

Panasonic®

Operating Instructions

Digital Camera/Lens Kit

Model No. **DMC-L1K**



LEICA
D VARIO-ELMARIT

WW™
FOURTHIRDS

SD™
HG

Before connecting, operating or adjusting this product,
please read the instructions completely.

For USA assistance, please call: 1-800-272-7033 or send e-mail to : digitalstillcam@panasonic.com

For Canadian assistance, please call: 1-800-561-5505 or visit us at www.panasonic.ca

PP

VQT0W82

Dear Customer,

We would like to take this opportunity to thank you for purchasing this Panasonic Digital Camera. Please read these Operating Instructions carefully and keep them handy for future reference.

Information for Your Safety

WARNING
TO REDUCE THE RISK OF FIRE OR SHOCK HAZARD AND ANNOYING INTERFERENCE, USE ONLY THE RECOMMENDED ACCESSORIES AND DO NOT EXPOSE THIS EQUIPMENT TO RAIN OR MOISTURE. DO NOT REMOVE THE COVER (OR BACK); THERE ARE NO USER SERVICEABLE PARTS INSIDE. REFER SERVICING TO QUALIFIED SERVICE PERSONNEL.

Carefully observe copyright laws. Recording of pre-recorded tapes or discs or other published or broadcast material for purposes other than your own private use may infringe copyright laws. Even for the purpose of private use, recording of certain material may be restricted.

- Please note that the actual controls and components, menu items, etc. of your Digital Camera may look somewhat different from those shown in the illustrations in these Operating Instructions.
- Four Thirds™ is a trademark.
- SDHC Logo is a trademark.
- Adobe is a trademark or registered trademark of Adobe Systems Incorporated in the United States and/or other countries.
- Leica is a registered trademark of Leica Microsystems IR GmbH.
- Elmarit is a registered trademark of Leica Camera AG.
- Other names, company names, and product names printed in these instructions are trademarks or registered trademarks of the companies concerned.

THE SOCKET OUTLET SHALL BE INSTALLED NEAR THE EQUIPMENT AND SHALL BE EASILY ACCESSIBLE.

CAUTION

Danger of explosion if battery is incorrectly replaced. Replace only with the same or equivalent type recommended by the manufacturer. Dispose of used batteries according to the manufacturer's instructions.



A lithium ion/polymer battery that is recyclable powers the product you have purchased. Please call 1-800-8-BATTERY for information on how to recycle this battery.

FCC Note: (U.S. only)

This equipment has been tested and found to comply with the limits for a Class B digital device, pursuant to Part 15 of the FCC Rules. These limits are designed to provide reasonable protection against harmful interference in a residential installation. This equipment generates, uses, and can radiate radio frequency energy and, if not installed and used in accordance with the instructions, may cause harmful interference to radio communications. However, there is no guarantee that interference will not occur in a particular installation. If this equipment does cause harmful interference to radio or television reception, which can be determined by turning the equipment off and on, the user is encouraged to try to correct the interference by one or more of the following measures:

- Reorient or relocate the receiving antenna.
- Increase the separation between the equipment and receiver.
- Connect the equipment into an outlet on a circuit different from that to which the receiver is connected.
- Consult the dealer or an experienced radio/TV technician for help.

FCC Caution: To assure continued compliance, follow the attached installation instructions and use only shielded interface cables with ferrite core when connecting to computer or peripheral devices.

Any changes or modifications not expressly approved by the party responsible for compliance could void the user's authority to operate this equipment.

Trade Name: Panasonic
Model No.: DMC-L1
Responsible party: Panasonic Corporation of North America
One Panasonic Way, Secaucus, NJ 07094
Support Contact: Panasonic Consumer Electronics Company
1-800-272-7033

This device complies with Part 15 of the FCC Rules. Operation is subject to the following two conditions: (1) This device may not cause harmful interference, and (2) this device must accept any interference received, including interference that may cause undesired operation.

This Class B digital apparatus complies with Canadian ICES-003



-If you see this symbol-

Information on Disposal in other Countries outside the European Union

This symbol is only valid in the European Union.

If you wish to discard this product, please contact your local authorities or dealer and ask for the correct method of disposal.



■ Care of the camera

- **Do not strongly shake or bump the camera.** The camera may stop operating normally, pictures may not be recorded or the lens may be damaged.
- **Sand or dust may cause the camera to malfunction. Make sure that sand or dust does not get into the lens or the terminals when using the camera on a beach etc.**
- Make sure that water does not get into the camera when using it on a rainy day or on a beach.
- **This unit is not waterproof. If rain water or other drops of water splash onto the camera, wipe it with a dry cloth.**
- **Do not put your hands inside the mirror.** Do not press, push or use a blower brush to forcefully blow air on the shutter curtains as they are very thin. Be careful as they may get scratched, bent or damaged.

■ About the LCD monitor

- **Do not press the LCD monitor with excessive force as it may cause the camera to malfunction.**
- Condensation may form on the LCD monitor in places with large temperature differences. Wipe the condensation with a soft, dry cloth.
- If the camera is cold when you turn it on, the picture on the LCD monitor will be slightly darker than usual at first. However, the picture will return to normal brightness when the internal temperature of the camera increases.

Extremely high precision technology is employed to produce the LCD monitor. However there may be some dark or bright spots (red, blue or green) on the screen. This is not a malfunction. The LCD monitor screen has more than 99.99% effective pixels with a mere 0.01% of the pixels inactive or always lit. The spots will not be recorded on pictures on a card.

■ **About the Lens**

- Do not press the lens with excessive force.
- Do not leave the camera with the lens facing the sun as it may cause the camera to malfunction. Also, be careful when you leave the camera outside or near a window.
- When there is dirt (water, oil, and fingerprints, etc.) on the surface of the lens, the picture may be affected. Lightly wipe the surface of the lens with a soft, dry cloth before and after taking pictures.
- Do not place the lens mount facing downwards. Do not allow the lens mount contacts ① to become dirty.

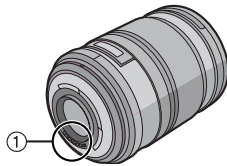

■ **About Condensation (When the lens or the Viewfinder is fogged up)**

- Condensation occurs when the ambient temperature or humidity changes as follows. Be careful of condensation since it causes lens stains, fungus and camera malfunction.
 - When the camera is taken from the cold outdoors to the warm indoors.
 - When the camera is taken from outside to inside an air-conditioned car.
 - When cool wind from an air conditioner etc. blows directly on the camera.
 - In humid places.
- To prevent condensation, put the camera in a plastic bag until the temperature of the camera is close to the ambient temperature. If condensation occurs, turn the camera off and leave it for about 2 hours. The fog will disappear naturally when the temperature of the camera becomes close to the ambient temperature.

■ **When not using the camera for a long period of time**

- Store the battery in a cool and dry place with a relatively stable temperature.
 [Recommended temperature: 15 °C to 25 °C (59 °F to 77 °F),
 Recommended humidity: 40% to 60%]
- Always remove the battery and the card from the camera.
- When the battery is left inserted in the camera, it will discharge even if the camera is turned off. If left like this the battery will discharge excessively and may become unusable even if charged.
- When storing the battery for a long period of time, we recommend charging it once a year. Remove the battery from the camera and store it again after it has completely discharged.
- We recommend storing the camera with a desiccant (silica gel) when you keep it in a closet or a cabinet.
- **If you have not used the camera for a long period of time, check all the parts before taking pictures.**

About These Operating Instructions

■ About indications in these operating instructions



Convenient or helpful information for using the camera is described.

■ About illustrations of the cursor button

In these operating instructions, operations using the cursor button are described with illustrations.

e.g.: When you press the ▼ button

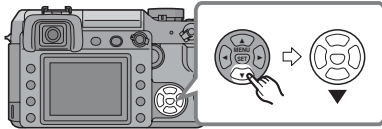

■ About the command dial

In these operating instructions, the operations on the command dial are described as illustrated to match the screen icon.

Rotate the command dial firmly and slowly.

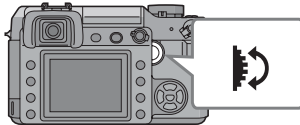

■ About illustrations in these operating instructions

The appearance of the product, the illustrations and menu screens etc. will differ slightly from those in actual use.

Contents

Before Use

Information for Your Safety	2
About These Operating Instructions	6

Preparation

Standard Accessories	10
Names of the Components	11
Screen Display	13
About the Lens	16
Attaching/Detaching the Lens	16
Charging the Battery with the Charger	18
About the Battery (charging/ number of recordable pictures)	19
Inserting/Removing the Battery	20
Using the AC Adaptor	21
Inserting/Removing the Card (Optional)	21
About the Card	22
Attaching the Lens Hood	23
Attaching the Strap	24
Attaching the Eyepiece Cap	25
Turning the Camera On	25
Setting Date/Time (Clock Set)	26
About the Setup Menu	27

Basic

Before Taking Pictures With the Viewfinder	31
• Tips for taking good pictures	31
• Making the Viewfinder easier to see (Diopter adjustment) ...	31
• Changing the information display on the LCD monitor	31
Matching the Focus and the Exposure Automatically (AF: Auto Focus/ Program AE mode)	32

• Taking good pictures	34
• Continuously focusing on a subject (AFC) (When taking pictures with the Viewfinder)	35
Aperture-priority AE	36
Shutter-priority AE	36
Manual Exposure	38
Compensating the Exposure	40
Taking Pictures with Manual Focus	42
Taking Pictures with the Zoom	43
Playing Back Pictures	44
• Changing the Information Displayed on the playback screen	45
Deleting Pictures	45
Using the Playback Zoom	47
Displaying Multiple Screens (Multi Playback)	48
Displaying Pictures by Recording Date (Calendar Playback)	49

Advanced

Switching to Live View	50
• Tips for taking good pictures with Live View	51
• Changing the Information Displayed	51
• Recording a picture with the camera held high above your head (High angle mode)	53
• Auto focus when taking pictures with Live View	54
• Manual focus when taking pictures with Live View	55
Checking the Depth of Field	57
Taking Pictures using the Built-in Flash	58
• Adjusting the flash output	61
• Bounce flash	62
Fixing the Focus and the Exposure (AF/AE Lock)	63
Taking Pictures using Burst Mode	64
Taking Pictures using Auto Bracket	66
Taking Pictures with the Self-timer	67
Adjusting the White Balance	68

• [WHITE SET] Resetting the white balance	70	• [SELF-TIMER] Setting the time for the self-timer	81
• [COLOR TEMPERATURE SETTING] Setting the color temperature	70	• [AF ASSIST LAMP] Focusing in low light conditions becomes easier	82
• [WHITE BALANCE ADJUSTMENT] Finely adjusting the white balance	70	• [OIS MODE] Optical Image Stabilizer	82
Setting the Light Sensitivity	71	• [AUTO BRACKET] Taking Pictures using Auto Bracket	83
Deciding the Method to Measure Brightness (Metering mode)	72	• [AF/AE LOCK] Switching the [AFL/AEL] button setting	83
<hr/> <hr/> Menu Settings <hr/> <hr/>		• [BURST RATE] Setting the burst speed	83
Setting Frequently Used Functions	73	• [FLASH SYNC.] Setting to the 2nd Curtain Synchro	83
Using the [REC] Mode Menu	75	Using the [CUSTOM] Menu	84
• [FILM MODE] Setting the color tone of the picture to be recorded	76	• Saving settings in [CUST. SET MEM.]	87
• [PICT.SIZE]/[QUALITY] Setting a picture size and quality that match your use of the pictures	78	Using the [PLAY] mode menu	88
• [RAW REC.] Recording a RAW file simultaneously	79	• [SLIDE SHOW] Playing back pictures in order for a fixed duration	89
• [ASPECT RATIO] Setting the aspect ratio of pictures (When taking pictures with Live View only)	79	• [FAVORITE] Setting your favorite pictures	90
• [EX. OPT. ZOOM] Enlarging a picture with no picture quality deterioration (When taking pictures with Live View only)	80	• [ROTATE DISP.]/[ROTATE] To display the picture rotated	91
• [D.ZOOM] Further extending the zoom (When taking pictures with Live View only)	81	• [DPOF PRINT] Setting the picture to print and the number of prints	92
		• [PROTECT] Preventing accidental erasure of pictures	94
		• [RESIZE] Making the picture smaller	94
		• [TRIMMING] Enlarging a picture and trimming it	95
		• [ASPECT CONV.] Changing the aspect ratio of a 16:9 picture	96
		• [FORMAT] Initializing the card	97

Connecting to other equipment









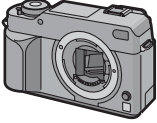

Connecting to a PC.....	98
Printing the Pictures.....	100
Playing Back Pictures on a TV Screen	104

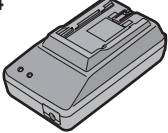
Others

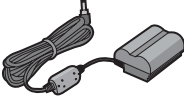
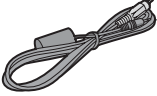
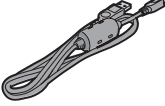
Using the External Flash.....	105
Using the MC Protector/PL Filter	106
Using the Remote Shutter	107
Displaying the Time at the Travel Destination (World Time)	108
• Location candidates for World Time settings.....	110
Cautions for Use	111
Message Display	114
Troubleshooting	115
Number of recordable pictures	120
Specifications.....	122
Digital Camera Accessory System	125
Digital Camera Accessory Order Form (For USA Customers).....	126
Request for Service Notice (For USA Only).....	127
Limited Warranty (For USA Only)	128
Customer Services Directory (For USA Only).....	130
Index	131
Spanish Quick Use Guide/ Guía rápida en español.....	133

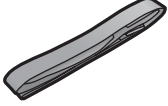
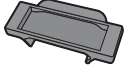
Standard Accessories

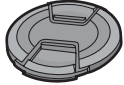
Check that all the accessories are included before using the camera.

1 	2 	3  CGR-S603A
4  DE-972A	5  K2CA2EA00002	6  K2GJ2DZ00028
7  K2KJ2CB00001	8  K1HA05CD0004	9 
10  VFC4189	11  VGQ8990	12  VKF4091
13  VYC0949	14  VYF3089	15  VFC4185
16  VFC4206		

- 1 Digital Camera Body
(This is referred to as **camera body** in these operating instructions.)
 - 2 Interchangeable Lens
"LEICA D VARIO-ELMARIT 14–50 mm/
F2.8–3.5"
(This is referred to as **lens** in these operating instructions.)
 - 3 Battery Pack
(This is referred to as **battery** in these operating instructions.)
 - 4 Battery Charger/AC Adaptor
(This is referred to as **AC adaptor** in these operating instructions.)
 - 5 AC Cable
 - 6 DC Cable
 - 7 Video Cable
 - 8 USB Connection Cable
 - 9 CD-ROM
 - 10 Strap
 - 11 Eyepiece Cap
(This is attached to the strap at the time of purchase.)
 - 12 Body Cap
(This is attached to the camera body at the time of purchase.)
 - 13 Lens Hood
 - 14 Lens Cap
(This is attached to the interchangeable lens at the time of purchase.)
 - 15 Lens Rear Cap
(This is attached to the interchangeable lens at the time of purchase.)
 - 16 Lens Storage Bag
- **The card is optional.**

Names of the Components

■ Camera body

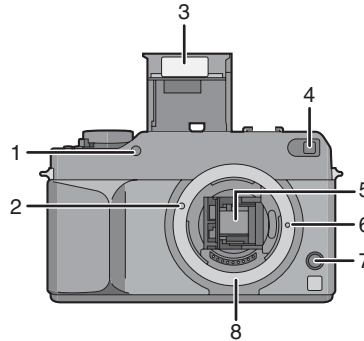

- 1 IR sensor (P69)
- 2 Lens fitting mark (P16)
- 3 Flash (P58)
- 4 AF assist lamp (P82)
Self-timer indicator (P67)
- 5 Mirror
- 6 Lens lock pin
- 7 Lens release button (P17)
- 8 Mount

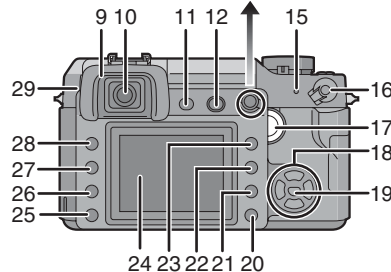

- 9 Eye cup (P25)
- 10 Viewfinder (P13, 31)
- 11 [LIVE VIEW] button (P50)
- 12 Flash open button (P58, 62)

Preparation

- 13 Focus mode lever (P32, 35, 42, 54, 55)
- 14 [AFL/AEL] button (P63)
- 15 Status indicator (P25)
- 16 Camera ON/OFF switch (P25)
- 17 Command dial (P33, 37, 38, 40, 47 to 49, 56, 58, 61, 68, 71, 73)
- 18 ◀/▶/▲ Cursor buttons (P27)
- 19 [MENU/SET] button (P27)
- 20 Delete button (P45)
- 21 Aperture stopping down button (P57)
- 22 [DISPLAY] button (P31, 45, 51, 53)
- 23 Playback button (P44, 45, 47 to 49, 104)
- 24 LCD monitor (P14, 31, 45, 50, 51, 53)
- 25 Flash output adjustment button (P61)
- 26 Flash button (P58, 105)
- 27 [ISO] button (P71)
- 28 [WB] button (P68)
- 29 Diopter adjustment dial (P31)

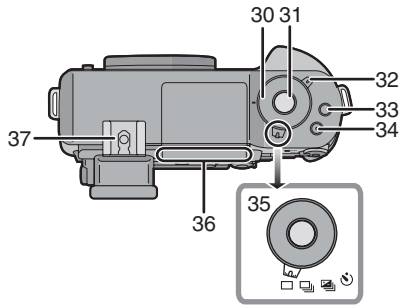

- 30 Shutter speed dial (P32, 36, 38)
- 31 Shutter button (P32)
- 32 Metering mode lever (P72)
- 33 [FUNC.1] button (P73)
- 34 [FUNC.2] button (P40, 73)
- 35 Drive mode lever
 - Single (P32): □
 - Burst (P64): ▭
 - Auto bracket (P66): ▣
 - Self-timer (P67): ⌚
- 36 Focus distance reference line (P42)
- 37 Hot shoe (P105)

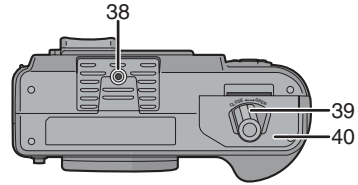

- 38 Tripod receptacle
 - When you use a tripod, make sure it is stable when the camera is attached to it.
- 39 Open/Close lever (P20)
- 40 Battery door (P20)

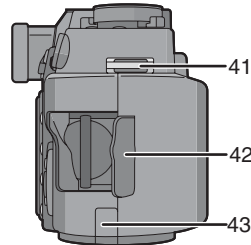

- 41 Strap eyelet (P24)
- 42 Card door (P21)
- 43 DC cable cover (P21)

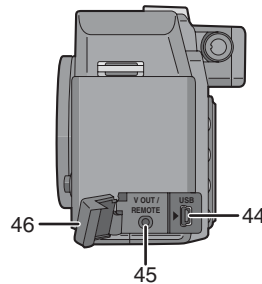

- 44 [USB] socket (P98, 100)
- 45 [V OUT/REMOTE] socket (P104, 107)
- 46 Terminal door

■ Lens

"LEICA D VARIO-ELMARIT 14–50 mm/
F2.8–3.5"

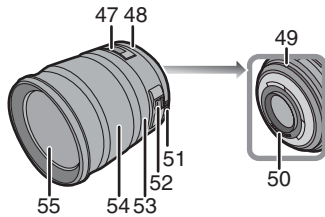

- 47 Focus distance indicator (P42, 55)
- 48 Aperture ring (P32, 36, 38)
- 49 Lens fitting mark (P16)
- 50 Contact point
- 51 Aperture ring button (P32, 36, 38)
- 52 [O.I.S.] switch (P17)
- 53 Focus ring (P42, 55)
- 54 Zoom ring (P43, 80, 81)
- 55 Lens surface

■ Battery charger/AC adaptor (P18)

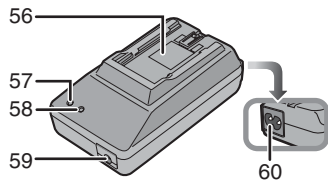

- 56 Battery holder
 - 57 [POWER] indicator
 - 58 [CHARGE] indicator
 - 59 Power output socket [DC OUT]
 - 60 Power input socket [AC IN]
- Do not use any other AC adaptors except the supplied one.

Screen Display

■ Viewfinder Display

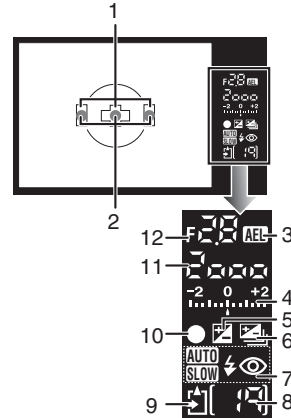

- 1 AF frame (P31, 32)
- 2 AF-LED (P86)
- 3 AE lock (P63)
- 4 Exposure compensation value (P40)/
Manual exposure assistance (P39)/
Auto bracket compensation range (P66)
- 5 Exposure compensation (P40)
- 6 Auto bracket (P66)
- 7 Flash setting (P58)
- 8 Number of recordable pictures
You can display up to 99 pictures only
on the Viewfinder.
- 9 Card access (P22)
- 10 Focus (P32)
- 11 Shutter speed (P32, 37, 38)
- 12 Aperture value (P32, 36, 38)

■ Information Display on the LCD Monitor
(When taking pictures with the Viewfinder)

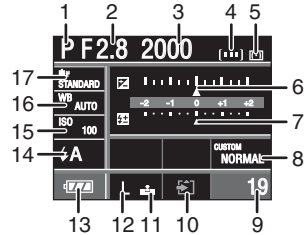

- 1 Recording mode (P32, 36, 38)
- 2 Aperture value (P36, 38)
- 3 Shutter speed (P36, 38)
- 4 AF frame setting (P85)
- 5 Metering mode (P72)
- 6 Exposure compensation (P40)
- 7 Flash output adjustment (P61)
- 8 Custom set (P87)
- 9 Number of recordable pictures
- 10 Card access (P22)
- 11 Quality (P78)
- 12 Picture size (P78)
- 13 Battery indication (P19)
- 14 Flash setting (P58)
- 15 ISO sensitivity (P71)
- 16 White balance (P68)
- 17 Film mode (P76)

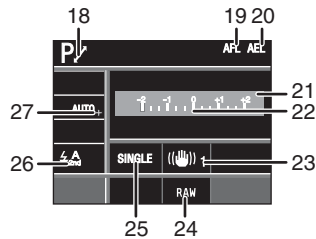

- 18 Program shift (P33)
- 19 AF lock (P63)
- 20 AE lock (P63)

- 21 Current date and time
This is displayed for about 5 seconds when the camera is turned on, after setting the clock and after switching from playback mode to recording mode.
- 22 Manual exposure assistance (P39)
- 23 Optical image stabilizer (P17, 82)
- 24 Recording a RAW file simultaneously ON/OFF (P79)
- 25 Single (P32): SINGLE
Burst (P64):
Auto bracket (P66): 1/3
Self-timer (P67):
- 26 2nd curtain synchro (P83): 2ND
- 27 White balance fine adjustment (P70)

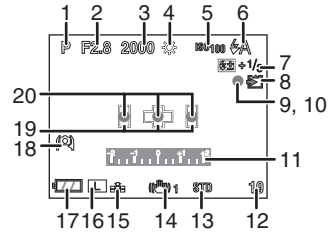

■ Live View Display on the LCD Monitor (P50)

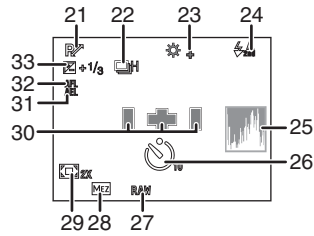

- 1 Recording mode (P32, 36, 38)
- 2 Aperture value (P54)
- 3 Shutter speed (P54)
- 4 White balance (P68)
- 5 ISO sensitivity (P71)
- 6 Flash setting (P58)
- 7 Flash output adjustment (P61)
- 8 Card access (P22)
Lights red.
- 9 Recording state
Flashes red.
- 10 Focus (P54)
Lights green.
- 11 Manual exposure assistance (P39)
- 12 Number of recordable pictures
- 13 Film mode (P76)
- 14 Optical image stabilizer (P17, 82)
- 15 Quality (P78)

- 16 Picture size (P78)
- 17 Battery indication (P19)
- 18 High angle mode (P53)
- 19 AF frame (P54)
- 20 Focus position (P54)



- 21 Program shift (P33)
- 22 Burst (P64): 
- Auto bracket (P66): 
- Self-timer (P67): 
- 23 White balance fine adjustment (P68)
- 24 2nd curtain synchro (P83): 2ND
- 25 Histogram (P52)
- 26 Self-timer (P67)
This is displayed during countdown.
- 27 Recording a RAW file simultaneously ON/OFF (P79)
- 28 Extended optical zoom (P80)
- 29 Digital zoom (P81)
- 30 AF frame setting (P85)
- 31 AE lock (P63)
- 32 AF lock (P63)
- 33 Exposure compensation (P40)

■ Playback Display on the LCD Monitor

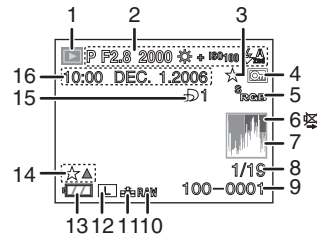

- 1 Playback mode (P44)
- 2 Recording information
- 3 Favorites (P90)
- 4 Protected picture (P94)
- 5 Color space (P86)
- 6 Cable disconnection warning icon (P103)
This is displayed when printing using a printer supporting PictBridge.
(Depending on the printer, the icon may not be displayed.)
- 7 Histogram (P52)
- 8 Picture number/Total pictures
- 9 Folder/File number (P99)
- 10 Recording a RAW file simultaneously ON/OFF (P79)
- 11 Quality (P78)
- 12 Picture size (P78)
- 13 Battery indication (P19)
- 14 Favorites settings (P90)
- 15 Number of DPOF prints (P92)
- 16 Recorded date and time

About the Lens

You can use the supplied lens or a lens that is compatible with the lens mount standard for the “Four Thirds System (Four Thirds Mount)” with this unit.

If you use a lens other than a dedicated interchangeable lens, auto focus cannot be activated and accurate metering is not possible. Also, some functions will not work.

■ “Four Thirds Mount”



This is the lens mount standard for the “Four Thirds System”.

These are interchangeable lenses newly developed specifically for the optical design requirements of digital cameras.

■ Using a lens from another manufacturer

- Some lenses from other manufacturers do not have an aperture ring. When you use a lens with no aperture ring, [FUNC.1] is fixed for aperture. Refer to P73 for more information about how to use [FUNC.1].
- Depending on the type of lens, you may not be able to use some functions.
- The available flash range etc. differs depending on the aperture value of the lens you are using.
- Take some test pictures with the lens you are using.

Attaching/Detaching the Lens

- Check that the camera is turned off.
- Close the flash.

■ Attaching a lens to the camera body

1 Turn the lens rear cap (A) and the body cap (B) in the direction of the arrow to detach them.

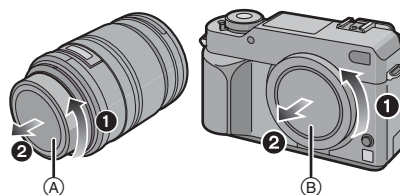

- Do not put your hands inside the mirror. (P11)

2 Align the lens fitting marks (C) (red marks) on the camera body and the lens and then rotate the lens in the direction of the arrow until it clicks.

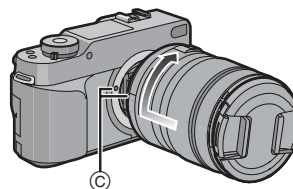

- Do not press the lens release button when you attach a lens.
- Do not try to attach the lens when holding it at an angle to the camera body as the lens mount may get scratched.
- Check that the lens is attached correctly.

3 Detach the lens cap.

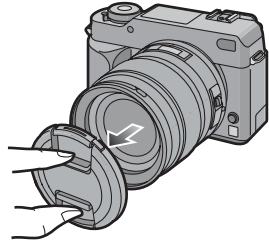

■ Optical image stabilizer

The supplied lens has an optical image stabilizer function.

The optical image stabilizer function is set for activation when the lens is attached to the camera body.

Set the [O.I.S.] switch to [ON].

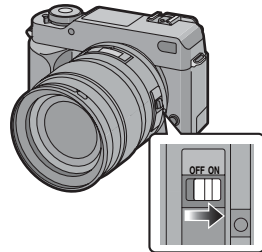

- You can change the optical image stabilizer mode to [MODE1] or [MODE2] using [OIS MODE] in the [REC] mode menu (P82). It is set to [MODE1] at the time of purchase.
- We recommend setting the [O.I.S.] switch to [OFF] when using a tripod. If the [O.I.S.] switch is set to [OFF], [(OFF)] is displayed on the LCD monitor.

■ Detaching a lens from the camera body

- Check that the camera is turned off.

1 Attach the lens cap.

2 Set the [O.I.S.] switch to [OFF].

3 Press the lens release button (D) while turning the lens as far as possible in the direction of the arrow to detach it.

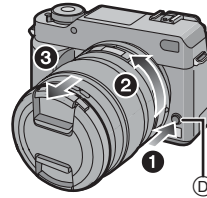

- Always attach the body cap to the camera body so that dirt or dust does not get inside.
- Attach the lens rear cap so that the lens contact point does not get scratched.



- Change lenses where there is not a lot of dirt or dust.
- When you turn the camera off or carry the camera, attach the lens cap to protect the surface of the lens.
- Detach the lens cap before taking pictures.
- **Be careful not to lose the lens cap, the lens rear cap and the body cap.**

Charging the Battery with the Charger

- The battery is not charged when the camera is shipped. Charge the battery before use.

1 Connect the AC cable.

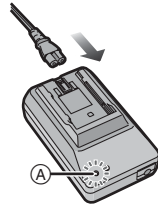

- When you connect the AC cable, the [POWER] indicator **A** lights red.
- The battery cannot be charged when the DC cable is connected to the AC adaptor.

2 Align the battery with the marks on the AC adaptor and then place it straight into the AC adaptor. Check that it is firmly attached.

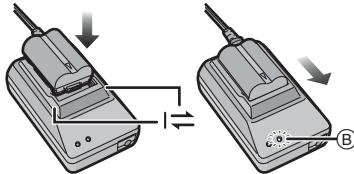

- Charging starts when the [CHARGE] indicator **B** lights green.

3 Detach the battery after charging is completed.

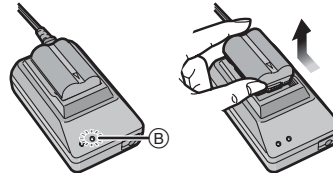

- Charging is completed when the [CHARGE] indicator **B** turns off (after about 130 minutes).



- After charging is completed, be sure to disconnect the AC cable from the electrical outlet.
- The battery becomes warm after using it and during and after charging. The camera also becomes warm during use. This is not a malfunction.
- The battery will be exhausted if left for a long period of time after being charged. Recharge the battery when it is exhausted.
- **Use the dedicated AC adaptor and battery.**
- **Use the AC adaptor indoors.**
- **Do not disassemble or modify the AC adaptor.**

About the Battery (charging/number of recordable pictures)

■ Battery indication

The remaining battery power appears on the screen.



- The battery indication turns red and blinks. (The status indicator blinks when the LCD monitor turns off.) Recharge the battery or replace it with fully charged battery. (This does not appear when using the AC adaptor.)

■ The battery life

**The number of recordable pictures when using the Viewfinder
(By CIPA standard in program AE mode)**

Number of recordable pictures	Approx. 450 pictures (Approx. 225 min)
--------------------------------------	---

Recording conditions by CIPA standard

- Temperature: 23 °C (73.4 °F)
Humidity: 50% when LCD monitor is on.
- Using Panasonic's SD Memory Card* (128 MB; optional).
- Using the supplied battery.
- Using the supplied lens.
- Starting recording 30 seconds after the camera is turned on. (When the optical image stabilizer function is set to [MODE1])
- **Recording once every 30 seconds** with full flash every second recording.
- Turn the camera off every 10 recordings.
- CIPA is an abbreviation of "Camera & Imaging Products Association".

*The card is optional.

**The number of recordable pictures varies depending on the recording interval time. If the recording interval time becomes longer, the number of recordable pictures decreases.
[e.g. When recording once every 2 minutes, the number of recordable pictures decreases to about 110.]**

**The number of recordable pictures when using the LCD monitor (Live View)
(The conditions are the same as the CIPA standard.)**

Number of recordable pictures	Approx. 300 pictures (Approx. 150 min)
--------------------------------------	---

Playback time

Playback time	Approx. 420 min
----------------------	-----------------

The number of recordable pictures and the playback time will vary depending on the operating conditions of the unit and the storing conditions of the battery.

■ Charging

Charging time	Approx. 130 min
----------------------	-----------------

The charging time and the number of recordable pictures with the optional battery pack (CGR-S603A) are the same as above.

- The [CHARGE] indicator lights when charging starts.

■ When the [CHARGE] indicator flashes

- The battery is over discharged (discharged excessively). In a while, the [CHARGE] indicator will light up and normal charging will start.
- When the battery temperature is excessively high or low, the charging time will be longer than normal.
- When the operating time of the camera becomes extremely short even after properly charging the battery, the life of the battery may have expired. Buy a new battery.

■ Charging conditions

- Charge the battery in a temperature between 10 °C to 35 °C. (50 °F to 95 °F). (The battery temperature should also be the same.)
- The performance of the battery may temporarily deteriorate and the operating time may become shorter in low temperature conditions (e.g. skiing/snowboarding).

Inserting/Removing the Battery

- Check that the camera is turned off.
- Close the flash.

1 Slide the release lever in the direction of the arrow (OPEN side) and then open the battery door.

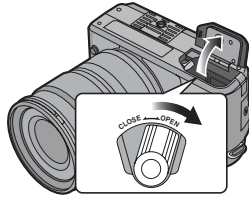

- Always use genuine Panasonic batteries (CGR-S603A).

2 Insert:
Insert the charged battery fully until it clicks.

Remove:
Push the lever (A) in the direction of the arrow to remove.

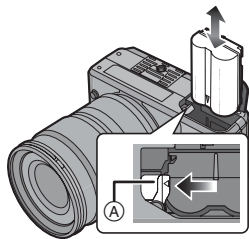

- Be careful of the direction indicated by the mark [▼] on the battery when inserting the battery.

3 ① Close the battery door.
② Slide the release lever in the direction of the arrow (CLOSE side) and then close it firmly.

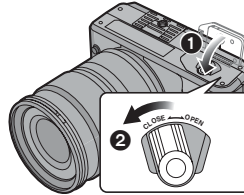

- Remove the battery after use.
- When a fully charged battery has been inserted for more than 24 hours, the clock setting is stored (in the camera) for at least 3 months even if the battery is removed. (If you insert a battery that is not sufficiently charged, the length of time that the clock setting is stored may be shorter.) The clock setting is canceled after this length of time. In this case, set the clock again. (P28)
- Do not remove the card or the battery while the card is being accessed. The data may be damaged. (P22)
- Turn the camera off and then remove the battery after the LCD monitor and the status indicator (green) turn off. If you remove the battery while the camera is on, the settings on the camera may not be stored properly.
- The supplied battery is designed only for the camera. Do not use it with any other equipment.

Using the AC Adaptor

You can use the camera without worrying about battery discharge when it is connected to a PC or printer if you use the AC adaptor.

- Check that the camera is turned off.
- Close the flash.

1 Connect the AC cable.

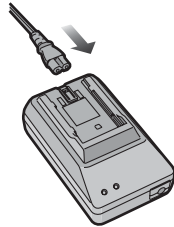

2 Connect the DC cable (A).

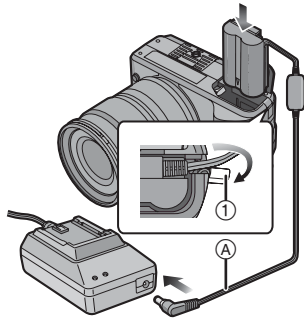

- Pull open the DC cable cover ① and then connect the DC cable to the camera body using the same steps as “Inserting/Removing the Battery” (P20). Pull the DC cable through the opening as shown in the illustration and then close the battery door.
- Be careful not to catch the DC cable when closing the battery door.



- Do not use any other AC adaptors except the supplied one.
- Do not use any other DC cables except the supplied one. If you use other DC cables, it may cause a malfunction.
- The camera becomes warm during use. This is not a malfunction.
- Disconnect the AC adaptor and DC cable when the camera is not in use.

Inserting/Removing the Card (Optional)

- Check that the camera is turned off.
- Close the flash.
- Prepare a card.

1 Slide the card door to open it.

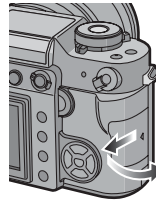

2 Insert:

Insert the card fully until it clicks and it is locked.

Remove:

Push the card until it clicks, then pull the card out upright.

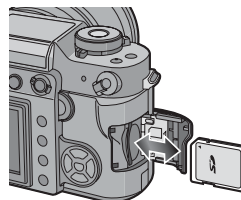

- Check the direction of the card.

Preparation

- Do not touch the connection terminals on the back side of the card.
- The card may be damaged if it is not fully inserted.

- 1 Close the card door.
- 2 Slide the card door to the end and then close it firmly.

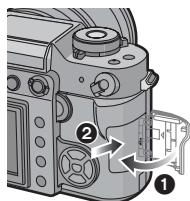

- If the card door cannot be completely closed, remove the card and insert it again.



- **Always turn the camera off before opening the card door.**
- **The card and the data may be damaged if it is inserted or removed while the camera is on.**
- **We recommend using a Panasonic SD Memory Card or SDHC Memory Card.**
- **You can purchase a Panasonic SD Memory Card or SDHC Memory Card from**
<http://www.panasonic.com>
<http://www.panasonic.ca>

About the Card

■ Access to the card

The card access indication (A) lights when pictures are being recorded onto the card.

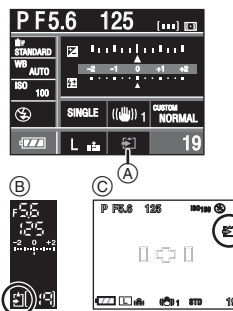

(B): Viewfinder Display

(C): When taking pictures with Live View
When the card access indication lights, pictures are being read or deleted or the card is being formatted (P97). Do not:

- turn the camera off.
- remove the battery or the card.
- shake or impact the camera.
- disconnect the DC cable if you use the AC adaptor.

The card and the data may be damaged or the camera may not operate normally.

■ About handling a card

Transfer important pictures from your card to your PC periodically (P98). The data on the card may be damaged or lost due to electromagnetic waves, static electricity, the camera breaking down or a defective card.

- Do not format the card on your PC or other equipment. Format it on the camera only to ensure proper operation. (P97)

- The reading/writing speed of an SD Memory Card and an SDHC Memory Card is fast. Both types of cards are equipped with a Write-Protect switch  that prevents writing and formatting the card. (If the switch is slid to the [LOCK] side, it is not possible to write or delete data on the card and format it. When the switch is slid to the other side, these functions become available.)

SD Memory Card



Please confirm the latest information on the following website.

<http://panasonic.co.jp/pavc/global/cs>

(This Site is English only.)

- Refer to P120 for information about the number of recordable pictures for each card.
- This camera is compatible with SD Memory Cards based on SD Memory Card Specifications and formatted in FAT12 system and FAT16 system. It is also compatible with SDHC Memory Cards based on SD Memory Card Specifications and formatted in FAT32 system.
- The SDHC Memory Card is a memory card standard decided by the SD Association in 2006 for high capacity memory cards more than 2 GB.
- This camera is compatible with both an SD Memory Card and an SDHC Memory Card. You can use an SDHC Memory Card in equipment that is compatible with SDHC Memory Cards however you cannot use an SDHC Memory Card in equipment that is only compatible with SD Memory Cards. (If you use an SDHC Memory Card in other equipment, always read the operating instructions for the other equipment.)



- The SD Memory Card, SDHC Memory Card and MultiMediaCard are small, lightweight, removable external cards.
- The reading/writing speed of a MultiMediaCard is slower than an SD Memory Card or an SDHC Memory Card. When a MultiMediaCard is used, the performance of certain features may be slightly slower than advertised.
- Keep the Memory Card out of reach of children to prevent swallowing.

Attaching the Lens Hood

In bright sunlight or backlight, the lens hood will minimize lens flare and ghosting. The lens hood cuts off excess lighting and improves the picture quality.

- Check that the camera is turned off.
- Close the flash.

Insert the lens hood on the lens with the short sides at the top and bottom and then turn it in the direction of the arrow until it clicks.

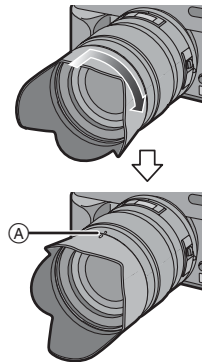

: Fitting to the mark.

■ **Temporarily storing the lens hood**

1 Turn the lens hood in the direction of the arrow to detach it.

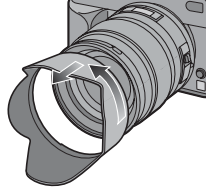

2 Reverse the lens hood and then attach it in the same way as shown previously.

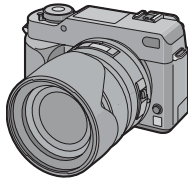

- Attach the lens cap.
- When temporarily storing the lens hood, check that it is firmly attached and that it does not appear in the picture.



- Hold the short sides of the lens hood when attaching or detaching it.
- When taking pictures with the flash with the lens hood attached, the lower portion of the screen may turn dark (vignetting effect) and the control of the flash may be disabled because the photo flash may be obscured by the lens hood. We recommend detaching the lens hood.
- When using the AF assist lamp in the dark, detach the lens hood.
- For details on how to attach the MC protector and the PL filter, refer to P106.
- For information about optional accessories, refer to the "Digital Camera Accessory System". (P125)

- If any accessories are lost, customers in the USA should contact Panasonic's parts department at 1 800 833-9626 and customers in Canada should contact 1 800 561-5505 for further information about obtaining replacement parts.

Attaching the Strap

1 Pass the strap through the hole at the strap eyelet.

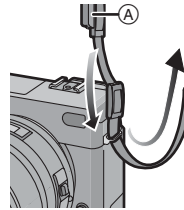

- Ⓐ: Eyepiece cap
- Attach the strap so that the side with the eyepiece cap attached to it is near the Viewfinder.

2 Pass the strap through the stopper and fasten the strap.

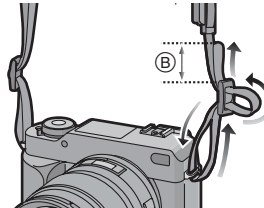

- Ⓑ: Pull the strap 2 cm (0.07 feet) or more.
- Attach the strap to the other side of the camera also so that it does not get twisted.



- Check that the strap is firmly attached to the camera.
- Attach the strap so that the "LUMIX" LOGO is on the outside.

Attaching the Eyepiece Cap

When taking pictures with your eye removed from the Viewfinder, light may enter the Viewfinder and affect the exposure and focus. Attach the eyepiece cap so that light does not enter the Viewfinder and prevent accurate exposure when taking pictures with Live View (P50) or the Self-timer (P67) and when using the remote shutter. (DMW-RSL1; optional) (P107)

1 Slide the eye cup from the bottom to detach it.

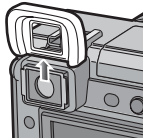

2 Slide the eyepiece cap from the top.

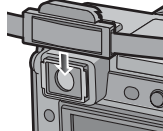

- The eyepiece cap is attached to the strap.

■ Attaching the eye cup

Slide the eye cup from the top.

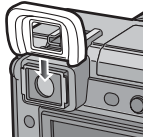

- Be careful not to lose the eye cup.
- Consult the dealer or your nearest servicenter if you lose the eye cup (VYQ3887).

Turning the Camera On

Set the camera ON/OFF switch to [ON].

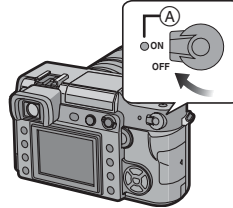

- The status indicator (A) lights when you set the switch to [ON]. The status indicator blinks if the remaining battery power becomes low.
- The camera turns off when you set the switch to [OFF].

Dust reduction function

When the camera is turned on, the dust reduction function is automatically activated to shake off any dust on the front part of the image sensor.

Setting Date/Time (Clock Set)

■ Initial setting

The clock is not set so the following screen appears when you turn the camera on.

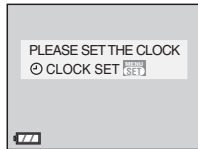
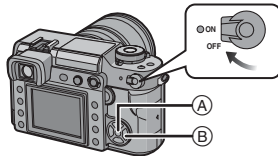

- A: [MENU/SET] button
- B: Cursor buttons

1 Press [MENU/SET].

2 Press ▲/▼/◀/▶ to select the date and time.

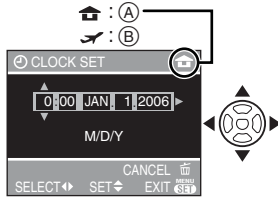

- A: Time at the home area
- B: Time at the travel destination (P108)
- ◀/▶: Select the desired item.
- ▲/▼: Set the display order for the date and time.
- Press [CANCEL] to cancel the time setup.
- Refer to [WORLD TIME] (P108) for information about setting the local time at the travel destination area [✈].

3 Press [MENU/SET] several times to close the menu.

- Turn the camera off after finishing setting the clock. Then turn it on and check that the clock setting is correct.

■ Changing the clock setting

- 1 Press [MENU/SET] to display the menu screen and then press ◀.
- 2 Press ▼ to select the [SETUP] menu icon [⌂] and then press ▶. (P27)
- 3 Press ▲/▼ to select [CLOCK SET] and then press ▶. Set as shown on steps 2 and 3.

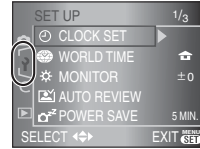

- When a fully charged battery has been inserted for more than 24 hours, the clock setting is stored (in the camera) for at least 3 months even if the battery is removed.
- You can set the year from 2000 to 2099. The 24-hour system is used.
- If the date is not set in the camera it will not be printed when you use a photo printing service, even if the store provides a date printing option for your photographs. (P93)

About the Setup Menu

- Set items as required. (Refer to P28 to 30 for each menu item.)
- The following example shows how to set [BEEP].
- Select [RESET] to return the settings to the initial settings at the time of purchase. (P29)

1 Press [MENU/SET] and then press **◀**.

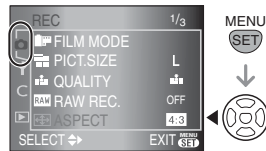

2 Press **▼** to select the [SETUP] menu icon [P] and then press **▶**.

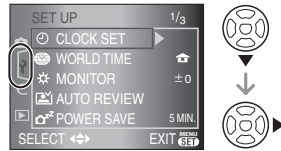

3 Press **▲/▼** to select the menu item.

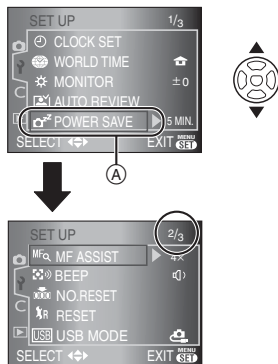

- Press **▼** at (A) to switch to the next menu screen.

4 Press **▶**, press **▲/▼** to select the setting and then press [MENU/SET].

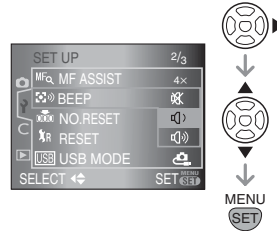

5 Press [MENU/SET] to close the menu.

- You can also press the shutter button halfway to close the menu.

■ About the menu screen items

- There are 3 menu screens in the [SETUP] menu (1/3, 2/3, and 3/3).

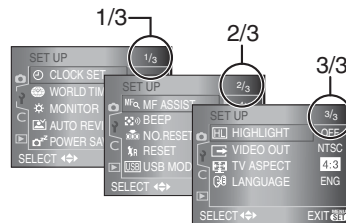



- You can also use the command dial when the instructions indicate to use **▲/▼**, e.g. when selecting menu items to set.
- The next menu screen after 3/3 in the [SETUP] menu is the first menu screen in the [CUSTOM] menu.

 **[CLOCK SET]**

Press [] to display the [SETUP] menu and select the item to set. (P27)
Change date and time. (P26)

 **[WORLD TIME]**

Press [] to display the [SETUP] menu and select the item to set. (P27)

[]: The local time at the travel destination area is set.

[]: The time at your home area is set.

- Refer to P108 for information about setting [WORLD TIME].

 **[MONITOR]**

Press [] to display the [SETUP] menu and select the item to set. (P27)

The brightness of the screen can be adjusted in 7 steps.

 **[AUTO REVIEW]**

Press [] to display the [SETUP] menu and select the item to set. (P27)

Review time

[1SEC.]/[2SEC.]/[3SEC.]:

The recorded picture appears for the set time. This is useful for confirming the focus.

[OFF]: The recorded picture does not appear automatically.

Zoom time

[1SEC.]/[2SEC.]/[3SEC.]:

The recorded picture is enlarged 4 times and appears on the screen for the set time. This is useful for confirming the focus.

The picture is not enlarged if you use burst mode, auto bracket or record a RAW file simultaneously.

[OFF]: The recorded picture does not appear automatically.

- If you use burst mode (P64), auto bracket (P66) or record a RAW file simultaneously (P79), the auto review function is activated regardless of the setting for auto review. (The picture is not enlarged.)

- If [HIGHLIGHT] (P29) is set to [ON], white saturated areas appear blinking in black and white when the auto review function is activated.

 **[POWER SAVE]**

Press [] to display the [SETUP] menu and select the item to set. (P27)

[1MIN.]/[2MIN.]/[5MIN.]/[10MIN.]:

Power save mode is activated (the camera is automatically turned off to save the battery life) if the camera has not been used for the time selected on the setting.

[OFF]: Power save mode is not activated.

- Press the shutter button halfway or turn the camera off and on to cancel power save mode.
- Power save mode is not activated when using the AC adaptor, connecting to a PC or a printer and during a slide show. (However, the setting for power save mode is fixed to [10 MIN.] while pausing a slide show or playing back a manual slide show.)

 **[MF ASSIST]**

(When taking pictures with Live View only)

Press [] to display the [SETUP] menu and select the item to set. (P27)

When taking pictures with Live View in manual focus, the whole of the screen on the LCD monitor is enlarged to facilitate focusing on the subject. (P55)

[4x]: The whole of the screen is enlarged 4 times.

[10x]: The whole of the screen is enlarged 10 times.

[OFF]: The screen is not enlarged.

[BEEP]

Press [MENU] to display the [SETUP] menu and select the item to set. (P27)

Set the volume of the focus confirmation beep, the self-timer beep, and the alarm beep.

- [X]: No beep
- [<]: Soft beep
- [<]: Loud beep

[NO.RESET]

Press [MENU] to display the [SETUP] menu and select the item to set. (P27)

Set this when you want the file number of the next recording to start from 0001.

(The folder number is updated and the file number starts from 0001.)

- A folder number between 100 and 999 can be assigned.
When the folder number reaches 999, the number cannot be reset. We recommend formatting the card after saving the data on a PC or elsewhere.
- To reset the folder number to 100, format the card first (P97) and then use this function to reset the file number.
A reset screen for the folder number will then appear. Select [YES] to reset the folder number.
- Refer to P99 for detailed information about the file number and the folder number.

[RESET]

Press [MENU] to display the [SETUP] menu and select the item to set. (P27)

The following settings are reset to the initial settings.

- [REC] mode menu settings
- [SETUP]/[CUSTOM] menu settings
- The following settings are also reset when you select [RESET].
 - [FILM MODE] (P76)
 - [CUST. SET MEM.] (P87)
 - [WORLD TIME] (P108)
 - [FAVORITE] in the [PLAY] mode menu (P90)

- The folder number and the clock setting are not changed.

[USB] [USB MODE]

Press [MENU] to display the [SETUP] menu and select the item to set. (P27)

Select the USB communication system after or before connecting the camera to your PC or your printer with the USB connection cable (supplied). (P98, 100)

[SELECT ON CONNECTION]:

Select either [PC] or [PictBridge (PTP)] if you connected the camera to a PC or a printer supporting PictBridge.

[PC]:

Set after or before connecting to a PC.

[PictBridge (PTP)]:

Set after or before connecting to a printer supporting PictBridge.

- When [PC] is selected, the camera is connected via the “USB Mass Storage” communication system.
- When [PictBridge (PTP)] is selected, the camera is connected via the “PTP (Picture Transfer Protocol)” communication system.

[HL] [HIGHLIGHT]

Press [MENU] to display the [SETUP] menu and select the item to set. (P27)

[ON]: When the auto review function is activated, white saturated areas appear blinking in black and white.

[OFF]: No highlight feature.

[ON]**[OFF]**

- If there are any white saturated areas, compensate the exposure towards negative (P40) referring to the histogram (P52) and then take the picture again. It may result in a better quality picture.

- There may be white saturated areas if the distance between the camera and the subject is too close when taking pictures with the flash. If [HIGHLIGHT] is set to [ON] in this case, these white saturated areas appear blinking in black and white.



[VIDEO OUT]

Press [] to display the [SETUP] menu and select the item to set. (P27)

[NTSC]: Video output is set to NTSC system.

[PAL]: Video output is set to PAL system.

- Video output is available in playback mode only.

[TV ASPECT]

Press [] to display the [SETUP] menu and select the item to set. (P27)

[16:9]:

Select this if connecting the camera to a 16:9 screen TV.

[4:3]:

Select this if connecting the camera to a 4:3 screen TV.

- The TV aspect setting is effective in playback mode only.
- **[16:9]** is suitable for displaying pictures recorded when the aspect ratio setting is **[16:9]** on the full screen of a 16:9 TV. However, pictures recorded when the aspect ratio setting is **[4:3]** or **[3:2]** will be displayed with black bands on the left and right of the screen.
- When **[4:3]** is selected, pictures recorded when the aspect ratio setting is **[16:9]** or **[3:2]** are displayed with black bands on the top and bottom of the screen.

- When you select **[16:9]** and use the Video cable (supplied) for output (P104), pictures are displayed vertically on the LCD monitor.

[LANGUAGE]

Press [] to display the [SETUP] menu and select the item to set. (P27)

Set the language on the menu screen from the following languages. Press **▲/▼** to set the desired language and then press [MENU/SET].

[ENGLISH]: English

[DEUTSCH]: German

[FRANÇAIS]: French

[ESPAÑOL]: Spanish

[ITALIANO]: Italian

[中文]: Chinese (Traditional)

[日本語]: Japanese

- If you set a different language by mistake, select [] from the menu icons to set the desired language.

Before Taking Pictures With the Viewfinder

Tips for taking good pictures

- Hold the camera gently with both hands, keep your arms still at your side and stand with your feet slightly apart.
- When taking pictures, make sure your footing is stable and there is no danger of colliding with another person, a ball etc.
- Make sure the camera does not shake when you press the shutter button.
- Do not cover the AF assist lamp, IR sensor etc. with your fingers or other objects.
- When holding the camera vertically, we recommend holding it with the AF assist lamp (A) at the top of the camera so you do not cover it with your fingers.

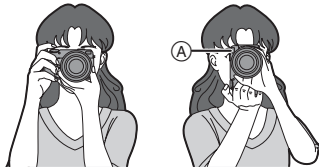

■ Direction detection function

Pictures recorded with the camera held vertically are played back vertically (rotated). (Only when [ROTATE DISP.] (P91) is set to [ON])

- Pictures may not be displayed vertically if they were taken with the camera aimed up or down.

Making the Viewfinder easier to see (Diopter adjustment)

Look at the Viewfinder in a bright place and then rotate the diopter adjustment dial to where the line of the AF frame (B) is clearest.

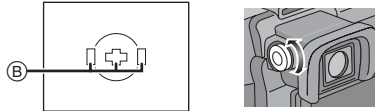

Changing the information display on the LCD monitor

Press [DISPLAY] to change.

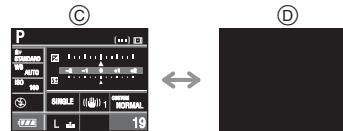

- Ⓒ: Normal display
- Ⓓ: No display

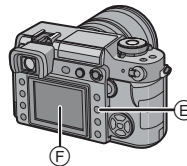

- Ⓔ: [DISPLAY] button
- Ⓕ: LCD monitor



- You can also take pictures while looking at the LCD monitor. (Live View)
Refer to P50 for more information.

Matching the Focus and the Exposure Automatically (AF: Auto Focus/Program AE mode [P])

The camera automatically sets the aperture value and the shutter speed according to the brightness of the subject.

- Remove the lens cap.
- Turn the camera on. (P25)
- Set the drive mode lever to [□].

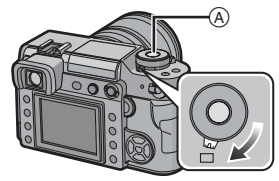

A: Shutter button

1 Set the focus mode lever to [AFS].

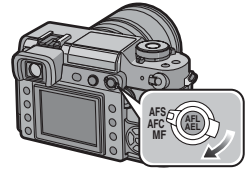

- AFS is an abbreviation of "Auto Focus Single". The focus is fixed when you press the shutter button halfway.

2 Rotate the shutter speed dial to [A].

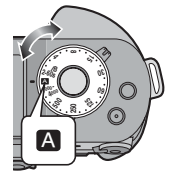

3 Rotate the aperture ring to [A], while pressing the aperture ring button [B].

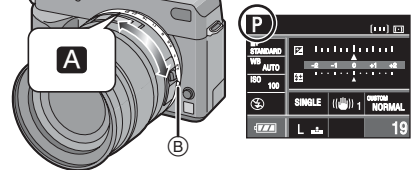

- The mode becomes program AE mode [P].

4 Aim the AF frame [C] to the point you want to focus on and then press the shutter button halfway.

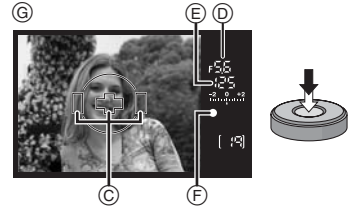

- ⓐ: Viewfinder Display
- You can check the aperture value [D] and shutter speed [E].
- The camera beeps and the focus indication [F] lights when the subject is focused.
- The focus indication blinks when the subject is not focused. In this case, a picture is not taken. Press the shutter button halfway to focus on the subject again.
- Refer to P34 for information about subjects that are difficult to focus on.

- The camera focuses on any of 3 focus area points- left, right or center - in the AF frame and a lamp (AF-LED display) lights where the subject is focused. You can change the setting for the AF frame and the AF-LED display in the [CUSTOM] menu. (P84)
- Refer to P33 for information about Program shift.
- **The focus range is 29 cm (0.95 feet) to ∞. (when the supplied lens is attached)**
- If the ISO sensitivity is set to [ISO100] and the aperture value is set to F2.8 (when the supplied lens is attached), the shutter speed is automatically set between about 4 seconds and 1/4000th of a second.

5 Press the shutter button fully to take the picture.



- A picture is not taken until the subject is brought into focus.
- If you want to press the shutter button fully to take a picture even when the subject is not focused, set [FOCUS PRIORITY] in the [CUSTOM] menu to [OFF]. (P86)



- We recommend checking that the clock is set properly before taking pictures. (P26)
- When a time is set for power save (P28), the camera automatically turns off if you do not operate it within the set time. To operate the camera again, press the shutter button halfway or turn the camera off and on.

- To avoid picture noise, we recommend reducing the ISO sensitivity before taking pictures. (P71) (ISO sensitivity is set to [AUTO] when the camera is shipped. Therefore, when taking pictures indoors etc. the ISO sensitivity increases.)
- When you use a lens with no aperture ring, press [FUNC.1] and then rotate the command dial to set the aperture.

■ Program shift

In program AE mode, you can change the preset aperture value and shutter speed without changing the exposure. This is called program shift.

You can make the background more blurred by decreasing the aperture value or record a moving subject more dynamically by slowing the shutter speed when taking a picture in program AE mode.

- Press the shutter button halfway and then press ▲/▼ or rotate the command dial (A) to activate program shift while the aperture value and the shutter speed are displayed on the Viewfinder (about 10 seconds).

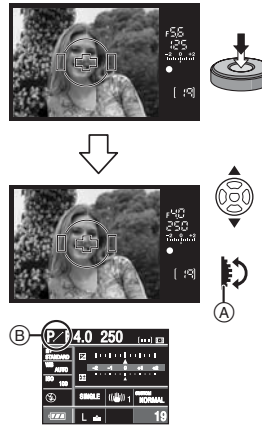

- The program shift indication (B) appears on the screen if program shift is activated.
- To cancel program shift, turn the camera off or rotate the command dial up and down until the program shift indication disappears.

■ Example of program shift when using the supplied lens

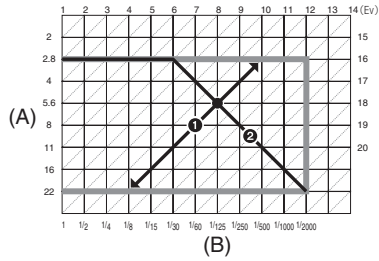

- (A): Aperture value
- (B): Shutter speed
- ① Program shift amount
- ② Program shift line chart



- If the exposure is not adequate when the shutter button is pressed halfway, the aperture value and the shutter speed on the LCD monitor (information display screen) turn red. The aperture value and the shutter speed blink on the Viewfinder. (They do not blink when the flash is activated.)
- Program shift is canceled and the camera returns to normal program AE mode if more than 10 seconds pass after program shift is activated. However, the program shift setting is memorized.
- Depending on the brightness of the subject, program shift may not be activated.

Taking good pictures

■ Focusing

- The focus range with auto focus is 29 cm (0.95 feet) to ∞. (when the supplied lens is attached)
 - If the distance between the camera and the subject is beyond the focus range of the camera, the picture may not be properly focused even if the focus indication lights.
 - The camera will not focus on subjects properly in the following cases.
 - When there are both near and distant subjects in a scene.
 - When there is dirt or dust on glass between the lens and the subject.
 - When there are illuminated or glittering objects around the subject.
 - When taking a picture in dark places.
 - When the subject is moving fast.
 - When the scene has low contrast.
 - When jitter occurs.
 - When recording a very bright subject.
 - When taking pictures of objects with a repeated pattern e.g. the windows on a building.
- We recommend taking pictures using AF/AE lock (P63). In dark places, the AF assist lamp (P82) may turn on for focusing on the subject.
- Even when the focus indication appears and the subject is focused, it is canceled if you release the shutter button. Press the shutter button halfway again.

■ Preventing jitter (camera shake)

- Be careful of jittering when pressing the shutter button.
- We recommend using a tripod. Also, be careful how you hold the camera (P31). Using the self-timer (P67) or the remote shutter (DMW-RSL1; optional) (P107) prevents jittering caused by pressing the shutter button when you are using a tripod.
- Shutter speed will be slower particularly in the following cases. Keep the camera still from the moment the shutter button is pressed until the picture is taken. We recommend using a tripod.
 - Slow sync. (P59)
 - Slow sync./Red-eye reduction (P59)
 - When you set to a slow shutter speed (P36, 38)

■ Exposure

- If you press the shutter button halfway when the exposure is not adequate, the aperture value (A) and the shutter speed (B) turn red. The aperture value and the shutter speed blink on the Viewfinder. (They do not blink when the flash is activated.)

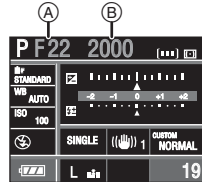

- When most of the subject is bright, such as during fine weather or snow, the recorded pictures may become dark. In these cases, compensate the exposure towards positive. (P40)

Continuously focusing on a subject (AFC) (When taking pictures with the Viewfinder)

This mode allows you to compose a picture more easily by continuously focusing on the movement of the subject while the shutter button is pressed halfway.

When taking pictures of a moving subject, the camera predicts the movement of the subject and focuses on it. (motion prediction)

- Check that the camera is set to taking pictures with the Viewfinder. When taking pictures with Live View, press [LIVE VIEW] to switch the setting so the camera is set to taking pictures with the Viewfinder. (P50)

Set the focus mode lever to [AFC].

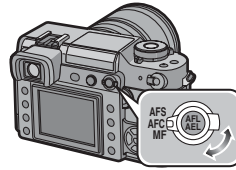

- AFC is an abbreviation of “Auto Focus Continuous”. The camera is continuously focusing on the subject while the shutter button is pressed halfway.
- It may take time to focus on the subject if you rotate the zoom ring from Wide to Tele or suddenly change the subject from a distant one to a nearby one.
- Press the shutter button halfway again when it is difficult to focus on the subject.
- Refer to P65 for information about focusing on the subject in burst mode.
- [AFC] in focus mode is not activated when taking pictures with Live View. If you switch the focus mode lever to [AFC], the message [SWITCH TO AFS] appears and [AFC] in focus mode is set.

Aperture-priority AE [A]

Set the aperture value to a higher number when you want a sharp focus background. Set the aperture value to a lower number when you want a soft focus background.

1 Rotate the shutter speed dial to [A].

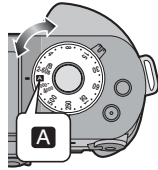

2 Rotate the aperture ring to set the aperture value.

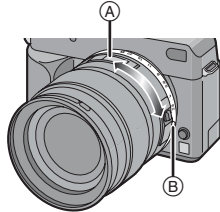

Ⓐ: [2.8] to [22]

- When changing from [A], rotate the aperture ring while pressing the aperture ring button Ⓑ.

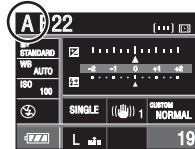

- The mode becomes Aperture-priority AE mode [A].

3 Take a picture.



- If you press the shutter button halfway when the exposure is not adequate, the aperture value and the shutter speed turn red. The aperture value and the shutter speed blink on the Viewfinder. (They do not blink when the flash is activated.)
- When most of the subject is bright, such as during fine weather or snow, the recorded pictures may become dark. In these cases, compensate the exposure towards positive. (P40)
- The ISO sensitivity cannot be set to [AUTO]. (The ISO sensitivity is automatically set to [ISO100] when you switch from [AUTO] to Aperture-priority AE.)
- When you use a lens with no aperture ring, press [FUNC.1] and then rotate the command dial to set the aperture.

Shutter-priority AE [S]

When you want to take a sharp picture of a fast moving subject, set with a faster shutter speed. When you want to create a trail effect, set to a slower shutter speed.

1 Rotate the aperture ring to [A] while pressing the aperture ring button Ⓐ.

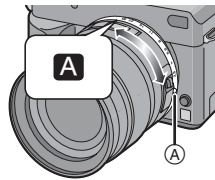

2 Rotate the shutter speed dial to set the shutter speed.

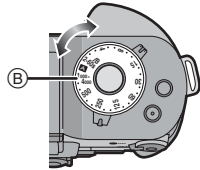

Ⓑ: [2-60s/B] to [1000-4000]

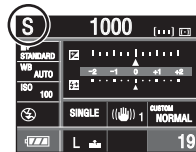

- The mode becomes Shutter-priority AE mode [**S**].
- If the shutter speed dial is set to [2-60s/B] or [1000-4000], press ▲/▼ or rotate the command dial Ⓒ to set the shutter speed.

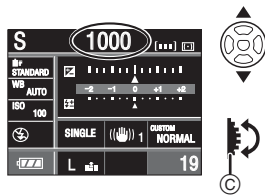

- You can set from 1/2 of a second to 60 seconds in steps of [1/3 EV] if the shutter speed dial is set to [2-60s/B].
- You can set from 1/1000th of a second to 1/4000th of a second in steps of [1/3 EV] if the shutter speed dial is set to [1000-4000].
- If you set [DIREC. EX. COMP.] (P85) to [ON], you cannot use the command dial.

3 Take a picture.



- When the flash is activated, the shutter speed becomes slower than 1/160th of a second regardless of the shutter speed setting. (P60)
- If you press the shutter button fully when the shutter speed is slow, the shutter speed on the screen counts down.
- We recommend using a tripod when the shutter speed is slow.
- If you press the shutter button halfway when the exposure is not adequate, the aperture value and the shutter speed turn red. The aperture value and the shutter speed blink on the Viewfinder. (They do not blink when the flash is activated.)
- When most of the subject is bright, such as during fine weather or snow, the recorded pictures may become dark. In these cases, compensate the exposure towards positive. (P40)
- The ISO sensitivity cannot be set to [AUTO]. (The ISO sensitivity is automatically set to [ISO100] when you switch from [AUTO] to Shutter-priority AE.)
- You cannot set Slow sync. [**⚡S**] and Slow sync./Red-eye reduction [**⚡S**] on the built-in flash.
- When you use a lens with no aperture ring, press [FUNC.1] and then rotate the command dial to set the aperture.

Manual Exposure [M]

Determine the exposure by manually setting the aperture value and the shutter speed.

1 Set the aperture value and the shutter speed.

Rotate the aperture ring to set the aperture value.

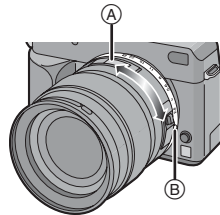

(A): [2.8] to [22]

- When changing from [A], rotate the aperture ring while pressing the aperture ring button (B).

Rotate the shutter speed dial to set the shutter speed.

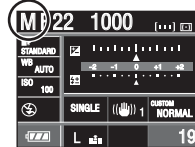
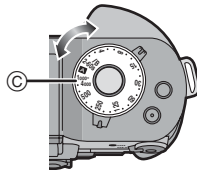

(C): [2-60s/B] to [1000-4000]

- The mode becomes manual exposure mode [M].
- If the shutter speed dial is set to [2-60s/B] or [1000-4000], press ▲/▼ or rotate

the command dial (D) to set the shutter speed.

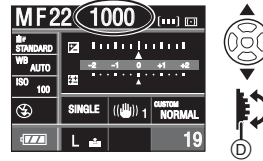

- You can set from 1/2 of a second to 60 seconds in steps of [1/3 EV] if the shutter speed dial is set to [2-60s/B]. The next setting after 60 seconds is [B] (Bulb). Refer to P39 for information about the B (Bulb) setting.
- You can set from 1/1000 of a second to 1/4000 of a second in steps of [1/3 EV] if the shutter speed dial is set to [1000-4000].
- If you set [DIREC. EX. COMP.] (P85) to [ON], you cannot use the command dial.

2 Press the shutter button halfway.

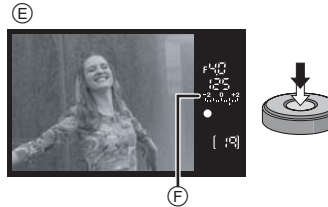



(E): Viewfinder Display

- Manual exposure assistance (F) appears for about 10 seconds to show an approximation of the exposure condition.
- If the exposure is not adequate, check the aperture value and the shutter speed that have been set.

3 Press the shutter button fully to take the picture.

■ Manual Exposure Assistance

	The exposure is adequate.
	Set to faster shutter speed or larger aperture value.
	Set to slower shutter speed or smaller aperture value.

- The manual exposure assistance is an approximation. We recommend checking the pictures using Auto Review.

■ About [B] (Bulb)

If you set the shutter speed to [B], the shutter stays open while the shutter button is pressed fully (up to about 8 minutes). The shutter closes if you release the shutter button.

Use this when you want to keep the shutter open for a long time to take pictures of fireworks, a night scene etc.

- If you set the shutter speed to [B], [Bulb] is displayed on the Viewfinder and [B] is displayed on the LCD monitor.
- When you take pictures with the shutter speed set to [B], use a sufficiently charged battery. (P19)
- We recommend using a tripod or the remote shutter (DMW-RSL1; optional) when you take pictures with the shutter speed set to [B]. Refer to P107 for information about the remote shutter.
- When you take pictures with the shutter speed set to [B], noise may become visible. To avoid picture noise, we recommend setting [LONG SHUTTER NR] in the [CUSTOM] menu to [ON] before taking pictures. (P87)
- The manual exposure assistance does not appear.



- If you press the shutter button fully when the shutter speed is slow, the shutter speed on the screen counts down.
- We recommend using a tripod when the shutter speed is slow.
- If the exposure is not adequate, the aperture value and the shutter speed turn red when the shutter button is pressed halfway. The aperture value and the shutter speed blink on the Viewfinder. (They do not blink when the flash is activated.)
- You cannot set the following items in manual exposure.
 - AUTO [A], AUTO/Red-eye reduction [A], Slow sync. [S] and Slow sync./Red-eye reduction [S] on the built-in flash
 - [AUTO] in ISO sensitivity (The ISO sensitivity is automatically set to [ISO100] when you switch from [AUTO] to Manual exposure.)
 - Exposure compensation
- When you use a lens with no aperture ring, press [FUNC.1] and then rotate the command dial to set the aperture.

Compensating the Exposure

Use this function when you cannot achieve appropriate exposure due to the difference in brightness between the subject and the background. Look at the following examples.

Under exposed



Compensate the exposure towards positive.



Properly exposed



Over exposed



Compensate the exposure towards negative.

■ If you are using [FUNC.2] to compensate the exposure ([FUNC.2] is set for compensating the exposure at the time of purchase.)

1 Press [FUNC.2] (A).

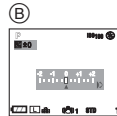
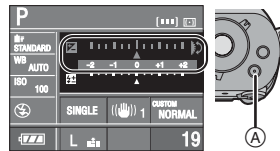

(B): When taking pictures with Live View

2 Rotate the command dial (C) to compensate the exposure.

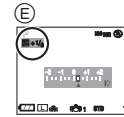
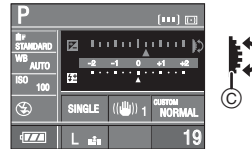

(D): Viewfinder Display

(E): When taking pictures with Live View

- Rotate the command dial upwards to compensate the exposure towards negative and rotate the command dial downwards to compensate the exposure towards positive.
- You can compensate from [-2 EV] to [+2 EV] in steps of [1/3 EV].
- Select [0] to return to the original exposure.
- [FUNC.2] and the selected exposure compensation value are displayed on the Viewfinder.

- The exposure compensation value is displayed on the LCD monitor when taking pictures with Live View. Refer to P50 for information about Live View.

3 Press the shutter button halfway to set the selected exposure.

- You can also set the selected exposure by doing the following:
 - Pressing [FUNC.2]
 - Not operating the camera for a few seconds

■ If you are using the command dial only to compensate the exposure

If you set [DIREC. EX. COMP.] to [ON], you can compensate the exposure by rotating the command dial only and do not have to press [FUNC.2]. (It is set to [OFF] at the time of purchase.)

1 Press [MENU/SET] and then press ◀.

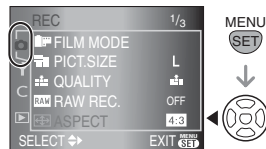

2 Press ▼ to select the [CUSTOM] menu icon [C] and then press ▶.

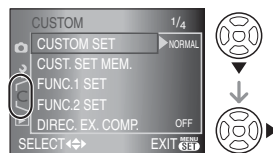

3 Press ▲/▼ to select [DIREC. EX. COMP.] and then press ▶.

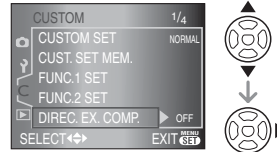

4 Press ▼ to select [ON] and then press [MENU/SET].

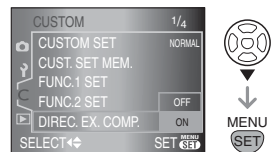

5 Press [MENU/SET] to close the menu.

- You can also press the shutter button halfway to close the menu.

- After performing steps 1 to 5, rotate the command dial to compensate the exposure.



- EV is an abbreviation of “Exposure Value”. It refers to the amount of light given to the CCD by the aperture value and the shutter speed.
- The set exposure value is memorized even if the camera is turned off.
- The compensation range of the exposure will be limited depending on the brightness of the subject.
- Rotate the command dial slowly but surely.
- You cannot compensate the exposure in manual exposure mode.
- Refer to P73 for information about setting a different function to [FUNC.2].

Taking Pictures with Manual Focus

Use this function when you want to fix the focus or when the distance between the lens and the subject is determined and you do not want to activate auto focus.

1 Set the focus mode lever to [MF].

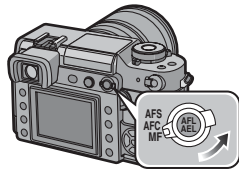

2 Rotate the focus ring to focus on the subject.

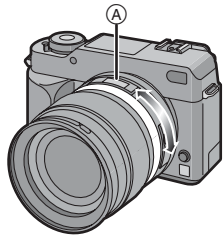

- The focus indication lights when the focus ring rotate to focus on the subject. The focus area is fixed to the AF frame on the center of the screen.
- The focus distance indicator ([0.29] m (0.95 feet) to [∞]) A shows the approximate "in focus" distance from the focus distance reference line. (P42)

3 Take the picture.



■ Technique for Manual focus



- 1 Rotate the focus ring.
- 2 Rotate it a little more.
- 3 Finely focus on the subject by rotating the focus ring slowly in reverse.



- If you use the zoom function after focusing on the subject, focus on the subject again.
- After turning the camera off and then on again or canceling power save mode, focus on the subject again.

■ About the focus distance indicator and the focus distance reference line

The number on the focus distance indicator A ([0.29] m (0.95 feet) to [∞]) is a measurement from the focus distance reference line ① on the top of the camera. Use this when taking pictures with manual focus or taking close-up pictures.

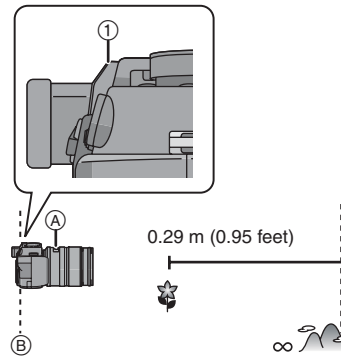

①: Focus distance reference line



- If the distance between the camera and the subject is beyond the focus range of the camera, the picture may not be properly focused even if the focus indication lights.
- The available flash range is about 2.5 m (8.2 feet) to 7.0 m (23.0 feet) (Wide) (When the ISO sensitivity is set to [AUTO].) We recommend setting the flash to Forced OFF [] when you take pictures at close range.
- If you are taking close-up pictures
 - We recommend using a tripod and the self-timer.
 - The effective focus range (depth of field) is significantly narrowed. Therefore, if the distance between the camera and the subject is changed after focusing on the subject, it may become difficult to focus on it again.
 - The resolution of the periphery of the picture may decrease slightly. This is not a malfunction.

Taking Pictures with the Zoom

With the 14 mm to 50 mm focal length of the supplied lens (35 mm film camera equivalent: 28 mm to 100 mm), you can make people and subjects appear closer (up to 3.6× optical zoom) and landscapes can be recorded in wide angle.

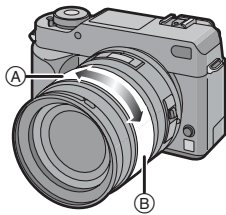

- (A): Tele
- (B): Wide

■ To make subjects appear closer use (Tele)

Rotate the zoom ring towards Tele.

50 mm
(35 mm film camera equivalent:
100 mm)



3.6×

■ To make subjects appear further away use (Wide)

Rotate the zoom ring towards Wide.

14 mm
(35 mm film camera equivalent:
28 mm)



1×



- If you use the zoom function after focusing on the subject, focus on the subject again.

Playing Back Pictures

1 Press [▶].



2 Press ◀/▶ to select the picture.



- ◀: Play back the previous picture
- ▶: Play back the next picture
- The first recorded picture will be displayed after the last recorded picture.
- When [ROTATE DISP.] is set to [ON], pictures recorded by holding the camera vertically are played back vertically. (P91)



■ Fast forwarding/Fast rewinding

Press and hold ◀/▶ during playback.

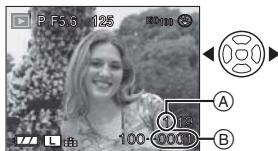

- ◀: Fast rewind
- ▶: Fast forward

- The file number (B) and the picture number (A) only change one by one. Release ◀/▶ when the number of the desired picture appears to play back the picture.
- If you press and hold ◀/▶, the number of files forwarded/rewound at one time increases. (The actual number of files forwarded/rewound at one time depends on the number of files recorded.)
- You can only fast forward or fast rewind pictures one by one in multi playback. (P48)

■ To finish playback

Press [▶] again or press the shutter button halfway.



- This camera is based on the DCF standard "Design rule for Camera File system" which was established by the "Japan Electronics and Information Technology Industries Association (JEITA)".
- The file format that can be played back on the camera is JPEG. (In some cases, even JPEG pictures cannot be played back.)
- The LCD monitor may not be able to display the details of the recorded pictures. You can use the playback zoom (P47) to check the details of the pictures.
- If you play back pictures that have been recorded with other equipment, the picture quality may deteriorate. (The pictures are displayed as [THUMBNAIL IS DISPLAYED] on the screen.)
- If you change a folder name or file name on your PC, the pictures may not play back on the camera.
- If you play back a non-standard file, the folder/file number is indicated by [—] and the screen may turn black.

Changing the Information Displayed on the playback screen

Press [DISPLAY] to switch the monitor screen.

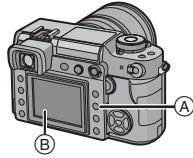

(A): [DISPLAY] button

(B): LCD monitor

- The [DISPLAY] button is not activated when the menu screen is displayed. You can only select Normal display or No display in playback zoom (P47) and during a slide show (P89).
- Refer to P52 for information about the histogram (E) and P86 for information about the color space (G).

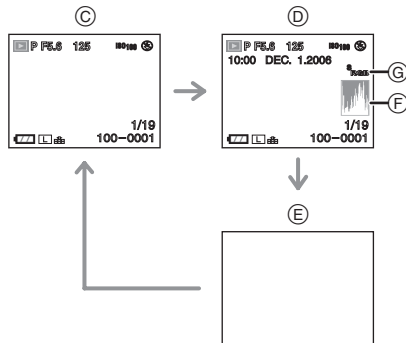

(C): Normal display

(D): Display with recording date, color space and histogram

(E): No display



- The histogram does not appear during the following.
 - Playback Zoom
 - Multi Playback
 - Calendar Playback

Deleting Pictures

Press [▶].



■ To delete a single picture

1 Select the picture with ◀/▶.



◀: Play back the previous picture

▶: Play back the next picture

2 Press [⏏].

3 Press ▲ to select [YES] and then press [MENU/SET].



- While the picture is being deleted, [🗑️] appears on the screen.

■ To delete [MULTI DELETE]/
[ALL DELETE]

1 Press [MENU] twice.

2 Press ▲/▼ to select [MULTI DELETE] or [ALL DELETE] and then press [MENU/SET].

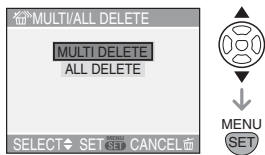

- If you select [MULTI DELETE], perform steps 3 onwards.
- If you select [ALL DELETE], perform steps 5 onwards.
- When [FAVORITE] (P90) is set to [ON], [ALL DELETE EXCEPT ★] appears. If you select [ALL DELETE EXCEPT ★], perform steps 5 onwards. (However, if none of the pictures have [★] displayed, you cannot select [ALL DELETE EXCEPT ★] even if [FAVORITE] is set to [ON].)

3 Press ◀/▶ to select the picture and then press ▼ to set.

(Only when selecting [MULTI DELETE])



- Repeat the above procedure.
- [MENU] appears on the selected pictures. If ▼ is pressed again, the setting is canceled.
- The icon [LOCK] blinks red if the selected picture is protected and cannot be deleted. Cancel the protect setting and then delete the picture. (P94)

4 Press [MENU].

5 Press ▲ to select [YES] and then press [MENU/SET].

(Screen when selecting [MULTI DELETE])

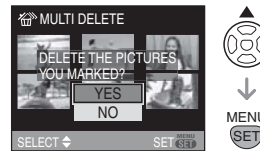

- [DELETE ALL PICTURES IN THE MEMORY CARD ?] is displayed when using [ALL DELETE] and [DELETE ALL EXCEPT ★ ?] is displayed when using [ALL DELETE EXCEPT ★].
- If you press [MENU/SET] while deleting pictures using [ALL DELETE] or [ALL DELETE EXCEPT ★], the deleting will stop halfway.



- Once deleted, pictures cannot be recovered. Double-check pictures before deleting them.
- Do not turn off the camera while deleting.
- Use a sufficiently charged battery (P19) or the AC adaptor when deleting.
- It is possible to delete up to 50 pictures at one time using [MULTI DELETE].
- The greater the number of pictures the longer it takes to delete them.
- The pictures are not deleted even if you select [ALL DELETE] or [ALL DELETE EXCEPT ★] in the following cases.
 - The Write-Protect switch on the SD Memory Card or the SDHC Memory Card is slid to the [LOCK] side (P23).
 - The file does not conform to the DCF standard (P44).
 - The pictures are protected [LOCK] (P94).

Using the Playback Zoom

1 Press [▶].

2 Rotate the command dial (A) downwards to enlarge the picture.

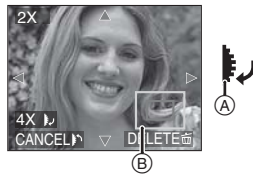

- 1× → 2× → 4× → 8× → 16×
- When you rotate the command dial upwards after enlarging a picture, the magnification becomes lower. When you rotate the command dial downwards, the magnification becomes higher.
- When you change the magnification, the zoom position indication (B) appears for about 1 second so that you can check the position of the enlarged section.

3 Press ▲/▼/◀/▶ to move the position.



- When you move the position to be displayed, the zoom position indication appears for about 1 second.

■ To stop using the playback zoom

Rotate the command dial upwards or press [MENU/SET].

■ To delete a picture during the playback zoom

- 1 Press [DELETE].
- 2 Press ▲ to select [YES].
- 3 Press [MENU/SET].



- Even if the indications on the screen are turned off in normal playback mode (P44), the magnification and operation appear on the screen when the playback zoom is activated. You can switch between displaying or not displaying the indications on the screen by pressing [DISPLAY]. When you set the magnification to 1×, the indications on the screen are displayed as in normal playback mode.
- The more a picture is enlarged, the rougher it becomes.
- If you want to save the enlarged picture, use the trimming function. (P95)
- The playback zoom may not operate if pictures have been recorded with other equipment.

Displaying Multiple Screens (Multi Playback)

1 Press [▶].

2 Rotate the command dial (A) upwards to display multiple screens.

(Screen when 9 screens are displayed)



- 1 screen→9 screens→25 screens→Calendar screen display (P49)
- After multiple screens are displayed, rotate the command dial further upwards to display 25 screens and the calendar screen (P49). Rotate the command dial downwards to return to the previous screen.

3 Press ▲/▼/◀/▶ to select a picture.



- The recording date and number of the selected picture and the total number of recorded pictures (B) are displayed.
- The favorites icon [★] is displayed for pictures set as favorites. (only when [FAVORITE] (P90) is set to [ON])

Examples of 25 screens



To return to normal playback

Rotate the command dial downwards or press [MENU/SET].

- The picture framed in orange is displayed on the 1 screen playback screen.

To delete a picture during multi playback

- 1 Press ▲/▼/◀/▶ to select a picture and then press [⏏].
- 2 Press ▲ to select [YES].
- 3 Press [MENU/SET].



- Even if the indications on the screen are turned off in normal playback mode (P44), the recording information etc. appears on the screen in multi playback. If you return to the previous screen, the indications on the screen are displayed as in normal playback mode.
- Pictures will not be displayed in the rotated direction even if [ROTATE DISP.] is set to [ON]. (P91)

Displaying Pictures by Recording Date (Calendar Playback)

You can display pictures by recording date using the calendar playback function.

1 Press [▶].

2 Rotate the command dial (A) upwards to display the calendar screen.



- The recording date of the picture selected in the playback screen becomes the date selected when the calendar screen is first displayed.
- If there are multiple pictures with the same recording date, the first picture recorded on that day is displayed.
- The calendar is displayed monthly.

3 Press ▲/▼/◀/▶ to select the date to be played back.

◀/▶: Select the date

▲/▼: Select the month

- If there were no pictures recorded during a month, the month is not displayed.

4 Press [MENU/SET] to display the pictures that were recorded on the selected date.



- The pictures that were recorded on the selected date are displayed on the 9 screens playback screen.
- Rotate the command dial upwards to return to the calendar screen.

5 Press ▲/▼/◀/▶ to select a picture and then press [MENU/SET].

- The selected picture is displayed on the 1 screen playback screen.

■ To return to the 1 screen playback screen

After the calendar screen is displayed, rotate the command dial downwards to display 25 screens, 9 screens (P48) and the 1 screen playback screen.



- The pictures are displayed without being rotated even if you set [ROTATE DISP.] to [ON]. (P91)
- You can display the calendar between January 2000 and December 2099.
- If the recording date of the picture selected in 25 screen multi playback is not between January 2000 and December 2099, the camera automatically displays it in the oldest calendar date.
- Pictures processed on a PC or other equipment may be displayed with dates different from the actual recording dates.
- If the date is not set in the camera (P26), the recording date is set as January 1st, 2006.
- If you take pictures after setting the travel destination in [WORLD TIME] (P108), the pictures are displayed by the dates at the travel destination in calendar playback.

Switching to Live View

You can also take pictures while looking at the LCD Monitor by using it as a Viewfinder. This is called Live View.

This is useful if you want to check the composition of the subject on the LCD Monitor when taking close-up pictures, using a tripod etc.

Press [LIVE VIEW] to switch the setting.

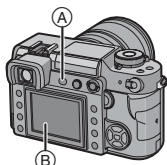

- (A): [LIVE VIEW] button
- (B): LCD monitor

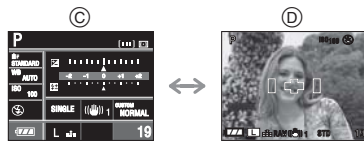

- (C): When taking pictures with the Viewfinder
- (D): When taking pictures with the Live View

■ You can do the following with Live View

• Guide lines display (P51)

You can take pictures with well-designed composition by viewing the balance of the subject.

• Histogram display (P52)

You can display the exposure of a picture as a graph.

• High angle mode (P53)

You can make the LCD monitor easier to see when taking a picture with the camera held high above your head.

• MF assist (P55)

You can enlarge a section of the screen for adjusting the focus.

• Aperture stopping down button [⊗] (P57)

You can check the depth of field without the screen becoming dark.

• Aspect ratio (P79)

You can take pictures with a wide angle of view.

• Extended optical zoom (P80)

You can enlarge the picture with no picture quality deterioration.

• Digital zoom (P81)

You can further enhance the zoom magnification.



- Refer to P14 for information about the screen display when taking pictures with Live View.
- Attach the eye piece cap when taking pictures with Live View. (P25)
- The exposure and the color tone may differ when taking pictures with Live View and when taking pictures with the Viewfinder.
- [AFC] in focus mode is not activated when taking pictures with Live View. (P35)
If you switch the focus mode lever to [AFC], the message [SWITCH TO AFS] appears and [AFC] in focus mode is set.

Tips for taking good pictures with Live View

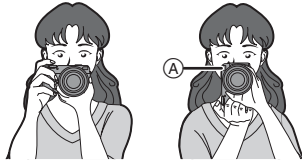

- Hold the camera gently with both hands, keep your arms still at your side and stand with your feet slightly apart.
- Make sure the camera does not shake when you press the shutter button.
- Do not cover the AF assist lamp, IR sensor etc. with your fingers or other objects.
- If the LCD monitor screen is difficult to see because of light from the sun etc. shining on it, we recommend using your hand or another object to block the light when using the camera.
- When holding the camera vertically, hold it with the AF assist lamp (A) at the top of the camera.

Changing the Information Displayed

Press [DISPLAY] to switch the monitor screen.

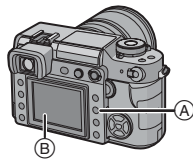

- (A): [DISPLAY] button
- (B): LCD monitor
- The [DISPLAY] button is not activated when the menu screen is displayed.
- You can set the information to display on the LCD monitor. (P87)

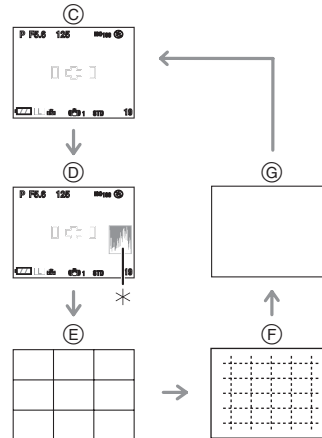

- (C): Normal display
- (D): Display with histogram
- (E): No display (Recording guide line 1)
- (F): No display (Recording guide line 2)
- (G): No display
- * Histogram

Recording guide lines display

When you align the subject on the horizontal and vertical guide lines or the cross point of these lines, you can take pictures with well-designed composition by viewing the size, the slope and the balance of the subject.

Guide line 1



■ Histogram

A histogram is a graph that displays brightness along the horizontal axis (black to white) and the number of pixels at each brightness level on the vertical axis. It allows you to easily check a picture's exposure.

- ❶ When the values are distributed evenly, the exposure is proper and the brightness is well-balanced.
- ❷ When the values are concentrated on the left, the picture is under exposed.
- ❸ When the values are concentrated on the right, the picture is over exposed.

Examples of histogram

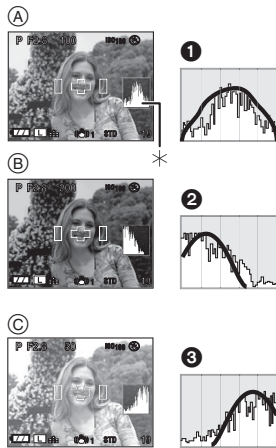

- (A) Properly Exposed
 - (B) Under Exposed
 - (C) Over Exposed
- *Histogram



• **When the recorded picture and the histogram do not match each other under the following conditions, the histogram is displayed in orange.**

- When the flash is activated.
- When the flash is closed.
 - ❶ When the brightness of the LCD monitor is not correctly displayed in dark places.
 - ❷ When the exposure is not adequately adjusted.
- The histogram is an approximation in recording mode.
- The histogram of a picture may not match in recording mode and playback mode.
- The histogram displayed in this camera does not match histograms displayed by picture editing software used in PCs etc.
- Check for any white saturated areas with the highlight feature when the auto review function is activated. (P29)

Recording a picture with the camera held high above your head (High angle mode)

The LCD monitor becomes easier to see when recording a picture with the camera held high above your head if the camera is held as shown in the following illustration. This is useful when you cannot get close to the subject because there is a person in the way.



Press [DISPLAY] (A) for 1 second.

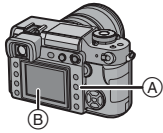

© High angle mode icon

- If you press [DISPLAY] for 1 second, high angle mode is activated. The LCD monitor (B) becomes brighter and easier to see when the camera is held away from you. (However it becomes more difficult to see when looked at straight on.)

■ **Canceling High angle mode**

Press and hold [DISPLAY] again for 1 second or turn the camera off.

- High angle mode is also canceled if power save mode is activated.



- Pictures are displayed on the LCD monitor with increased brightness in High angle mode. Therefore, some subjects may look different on the LCD monitor. However, this does not affect the recorded pictures.
- You may not notice the High angle mode effect if the LCD monitor is difficult to see because of light from the sun etc. shining on it. In this case, we recommend using your hand or another object to block the light when using the camera.
- High angle mode is not activated in the following cases:
 - In playback mode
 - While the menu screen is displayed

Auto focus when taking pictures with Live View

1 Set the focus mode lever to [AFS]. (P32)

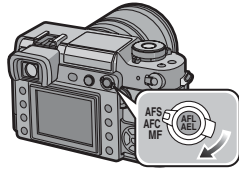

2 Aim the AF frame (D) to the point you want to focus on and then press the shutter button halfway.

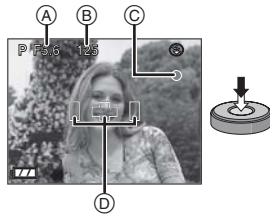

- When you press the shutter button halfway, the mirror goes down and then goes up to enable the camera to focus. At this time, the same sound is heard as when the shutter button is pressed fully. However a picture is not taken.
- The camera beeps and the focus indication lights (green) (C) when the subject is focused.
- The focus indication blinks (green) when the subject is not focused. In this case, a picture is not taken. Press the shutter button halfway to focus on the subject again.
- Refer to P34 for information about subjects that are difficult to focus on.
- You can check the aperture value (A) and the shutter speed (B).

- The camera focuses on any of the 3 focus area points-left, right or center-in the AF frame and the focus position indication lights where the subject is focused. You can change the setting for the AF frame in the [CUSTOM] menu. (P85)
- Refer to P33 for information about the program shift.
- **The focus range is 29 cm (0.95 feet) to ∞. (when the supplied lens is attached)**

3 Press the shutter button fully to take the picture.

- A picture is not taken until the subject is brought into focus.
- If you want to press the shutter button fully to take a picture even when the subject is not focused, set [FOCUS PRIORITY] in the [CUSTOM] menu to [OFF]. (P86)
- The shutter sound is heard twice when 1 picture is taken. The first shutter sound is heard when the shutter returns to the position before a picture is taken and the second shutter sound is heard when the picture is actually taken.



- If the shutter button is pressed fully and then released, the shutter sound is heard. However a picture is not taken.
- The time between pressing the shutter button fully and the picture being taken (release time lag) is longer than when taking pictures with the Viewfinder. Therefore, we recommend checking the pictures using Auto Review.
- If you press the shutter button halfway when the exposure is not adequate, the aperture value and the shutter speed turn red. (They do not turn red when the flash is activated.)
- The brightness of the LCD monitor may differ from the brightness of the recorded pictures especially when recording in dark places.

Manual focus when taking pictures with Live View

1 Set the focus mode lever to [MF].

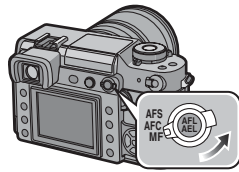

2 Rotate the focus ring to focus on the subject.

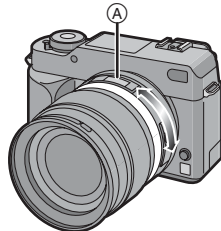

Ⓐ: [0.29] m (0.95 feet) to [∞]



- The focus distance indicator ([0.29] m (0.95 feet) to [∞]) show the approximate “in focus” distance from the focus distance reference line. (P42)

3 Take the picture.

■ Technique for Manual focus

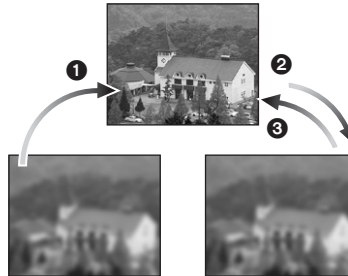

- 1 Rotate the focus ring.
- 2 Rotate it a little more.
- 3 Finely focus on the subject by rotating the focus ring slowly in reverse.

■ About MF Assist

If [MF ASSIST] is set to [4×] or [10×] while taking pictures with manual focus, MF assist is activated and the screen is enlarged when you press [MENU/SET] after pressing ◀/▶. This allows you to focus on the subject more easily.

1 Press ◀/▶ to display the MF assist screen.

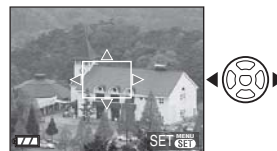

2 Press ▲/▼/◀/▶ to change the position of the MF assist screen.



3 Press [MENU/SET] to magnify the MF assist screen.

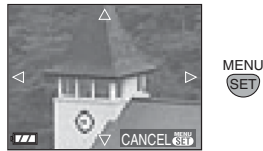

- Rotate the focus ring to focus on the subject.
- The enlarged area can be moved by pressing ▲/▼/◀/▶.

4 Press [MENU/SET] to close MF assist.



- The screen returns to the previous screen.

■ Changing the magnification

1 Press [MENU/SET] and then press ◀.

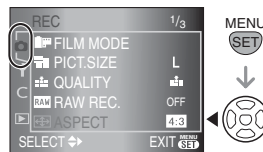

2 Press ▼ to select the [SETUP] menu icon [⌂] and then press ▶.

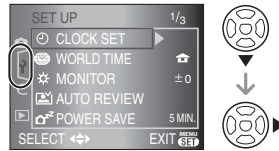

3 Press ▲/▼ to select [MF ASSIST] and then press ▶.

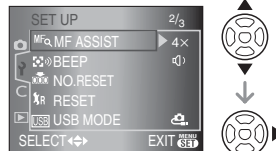

4 Press ▲/▼ to select [4×] or [10×] and then press [MENU/SET].

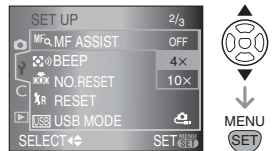

- [4×]: The whole of the screen is enlarged 4 times.
- [10×]: The whole of the screen is enlarged 10 times.
- [OFF]: The screen is not enlarged.

5 Press [MENU/SET] to close the menu.

- You can also close the menu by pressing the shutter button halfway.

■ Changing the magnification with the MF assist screen

You can magnify the whole of the screen 10 times or 4 times while the MF assist screen is enlarged by rotating the command dial.



- The MF assist disappears in the following cases.
 - About 10 seconds after you stop pressing ▲/▼/◀/▶ or rotating the focus ring or the command dial
 - When the shutter button is pressed halfway
- The MF assist returns to the center of the screen when the camera is turned off and then on again.
- You cannot use MF assist when using the digital zoom.

Checking the Depth of Field

You can check the depth of field (effective focus range) before taking a picture by closing the leaf shutter to the aperture value you set.

Press [] (A) (aperture stopping down button).

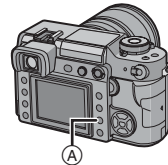

- While you are pressing [] (aperture stopping down button), the brightness of the screen is automatically adjusted and you can check the depth of field without the screen becoming dark when the leaf shutter closes.

■ Depth of field properties

	Aperture value	Small	Large
*1	Focus length of the lens	Tele	Wide
	Distance to the subject	Near	Distant
	Depth of field (effective focus range)	Shallow (Narrow)*2	Deep (Wide)*3

*1 Recording conditions

*2 Example: When you want to take a picture with a blurred background etc.

*3 Example: When you want to take a picture with everything in focus including the background etc.



- The screen may become dark depending on the subject, settings on the camera etc.
- [] (aperture stopping down button) is not activated when taking pictures with the Viewfinder.

Taking Pictures using the Built-in Flash

■ Open the flash

Press the [FLASH OPEN] button (A).

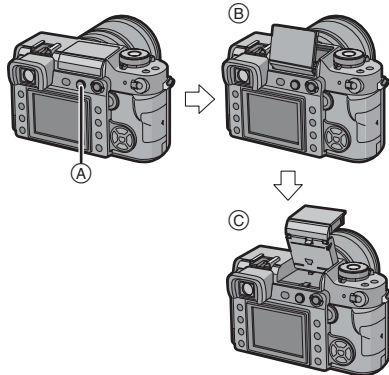

- If you press the [FLASH OPEN] button lightly, the flash will open to the bounce flash position (B). If you press the [FLASH OPEN] button fully, the flash will open to the normal flash position (C).
- Use the flash in the normal flash position when taking pictures with the flash normally.

■ Close the flash

- 1: Press the flash down until it locks into the bounce flash position.
- 2: Close the flash firmly.

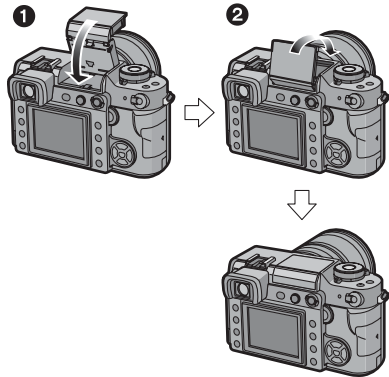

- This camera is compatible with bounce flash so the flash opens and closes in two steps. Refer to P62 for information about the bounce flash.
- Be sure to close the flash when not in use.

■ Switching to the appropriate flash setting

Set the flash to match the recording.

1 Press [FLASH] (D).

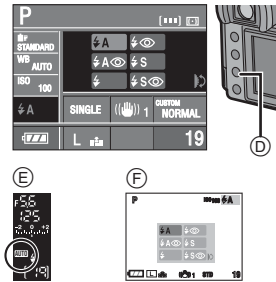

- (E): Viewfinder Display
- (F): When taking pictures with Live View

2 Rotate the command dial (G) and select the flash setting.

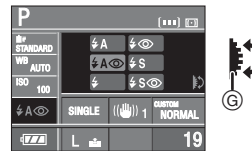

- Refer to “Available flash setting by recording mode” on P59 for information about the flash settings for the built-in flash that can be selected.
- Refer to P83 for setting the 1st and 2nd curtain.

3 Press the shutter button halfway to set the selected flash setting.

- You can also set the selected flash setting by doing the following:
 - Pressing []
 - Not operating the camera for a few seconds

A : AUTO

The flash is automatically activated when the recording conditions make it necessary.

A : AUTO/Red-eye reduction*

The flash is automatically activated when the recording conditions make it necessary. It is activated once before the actual recording to reduce the red-eye phenomenon (eyes of the subject appearing red in the picture) and then activated again for the actual recording.

- Use this when you take pictures of people in low lighting conditions.

: Forced ON

The flash is activated every time regardless of the recording conditions.

- Use this when your subject is back-lit or under fluorescent light.

: Forced ON/ Red-eye reduction*

The flash is activated every time regardless of the recording conditions. Simultaneously it reduces the red-eye phenomenon.

- Use this when your subject is back-lit or under fluorescent light.

S : Slow sync.

If you take a picture with a dark background landscape, this feature will slow the shutter speed when the flash is activated so that the dark background landscape will become bright.

- Use this when you take pictures of people in front of a dark background.

S : Slow sync./Red-eye reduction*

If you take a picture with a dark background landscape, this feature will slow the shutter speed when the flash is activated so that the dark background landscape will become bright. Simultaneously it reduces the red-eye phenomenon.

- Use this when you take pictures of people in front of a dark background.

: Forced OFF

The flash is fixed to Forced OFF [] when it is closed.

The flash is not activated in any recording conditions.

- Use this when you take pictures in places where the use of the flash is not permitted.

- * The flash is activated twice. The interval between the first and second flash is longer when [A], [] or [S] is set. The subject should not move until the second flash is activated.

Available flash setting by recording mode

The available settings for the built-in flash differ depending on the recording mode. (○: Available, —: Not available)

	P	A	S	M
A	○	○	○	—
A	○*	○*	○*	—
	○	○	○	○
	○*	○*	○*	○*
S	○	○	—	—
S	○*	○*	—	—
	○	○	○	○

- * When setting to the 2nd Curtain Synchro, flash setting is not available.

■ **The available flash range to take pictures (when the supplied lens is attached)**





The available flash settings for the built-in flash differ depending on the ISO sensitivity setting.

ISO sensitivity	the available flash range to take pictures	
	Wide	Tele
AUTO	2.5 m (8.2 feet) to 7.0 m (23.0 feet)	1.0 m (3.3 feet) to 5.6 m (18.4 feet)
ISO100	2.5 m (8.2 feet) to 3.5 m (11.5 feet)	1.0 m (3.3 feet) to 2.8 m (9.2 feet)
ISO200	2.5 m (8.2 feet) to 5.0 m (16.4 feet)	1.0 m (3.3 feet) to 4.0 m (13.1 feet)
ISO400	2.5 m (8.2 feet) to 7.0 m (23.0 feet)	1.0 m (3.3 feet) to 5.6 m (18.4 feet)
ISO800	2.5 m (8.2 feet) to 9.8 m (32.1 feet)	1.0 m (3.3 feet) to 7.8 m (25.6 feet)
ISO1600	2.5 m (8.2 feet) to 14.0 m (46.0 feet)	1.0 m (3.3 feet) to 11.2 m (36.7 feet)

- Refer to P71 for the ISO sensitivity.
- Refer to P34 for the focus range.
- If ISO sensitivity is set to [AUTO] when using the flash, it will be automatically increased to a maximum of [ISO400].

- If the distance between the camera and the subject is less than 2.5 m (8.2 feet) when taking a picture with the flash, the photo flash will be obscured by the lens and one part of the screen will become dark. Check the distance between the camera and the subject when taking a picture.
- To avoid picture noise, we recommend reducing the ISO sensitivity before taking pictures. (P71)

■ **Shutter speed for each flash setting (When the built-in flash is activated)**

	P	A	S	M
	1/30th of a second		60 seconds to 1/160th of a second	cannot set a flash setting
				
	1/30th of a second to 1/160th of a second			B (Bulb) to 1/160th of a second
	1 second to 1/160th of a second			
				cannot set a flash setting

- The flash sync. speed becomes more than 1/160th of a second.



- **Do not look directly at the flash at close range when it is activated.**
- **Do not bring the flash too close to objects or close the flash while it is activated. The objects may be discolored by its heat or lighting.**
- **Do not cover the photo flash with your fingers or other objects.**
- Do not carry the camera using the opened built-in flash.
- Do not close the flash soon after it is activated prior to taking pictures due to auto/red-eye reduction etc. It causes a malfunction.
- If you press the shutter button halfway when the flash is activated, the flash icon on the LCD monitor turns red.

- When you take a picture beyond the available flash range, the exposure may not be adjusted properly and the picture may become bright or dark.
- The white balance may not be properly adjusted if the flash level is insufficient. (P68)
- If you repeat taking a picture, it may not actually be taken even if the flash is activated. Take a picture after the access indication disappears.
- The red-eye reduction effect differs between people. Also, if the subject was far away from the camera or was not looking at the first flash, the effect may not be evident.
- When the flash is being charged, the flash icon blinks red, and you cannot take a picture even when you press the shutter button fully.
- When taking pictures in burst mode or auto bracket, only 1 picture is recorded for every flash activated.
- **If you take pictures with the flash when the lens hood is attached, the flash may be obscured by the lens hood.**
- When you attach an external flash, it takes priority over the built-in flash. Refer to P105 for the external flash.

Adjusting the flash output

Adjust the flash output when the subject is small or reflection ratio is extremely high or low.

1 Press [**FLASH**] (A).

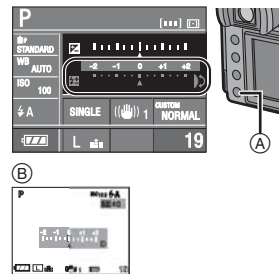

(B): When taking pictures with Live view

2 Rotate the command dial (C) to adjust the flash output.

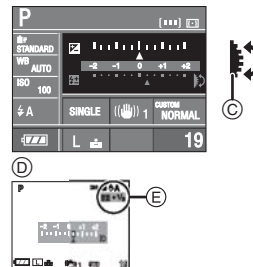

(D): When taking pictures with Live view

- Rotate the command dial upwards to adjust towards negative and rotate the command dial downwards to adjust towards positive.
- You can adjust from [-2 EV] to [+2 EV] in steps of [1/3 EV].
- Select [0] to return to the original flash output.
- The flash output adjustment value (E) is displayed on the LCD monitor when taking pictures with Live View.

3 Press the shutter button halfway to set the selected flash output.

- You can also set the selected flash output by doing the following:
 - Pressing []
 - Not operating the camera for a few seconds



- The flash output setting is memorized even if the camera is turned off.

Bounce flash

Bounce flash is a technique where the light from the flash is reflected off a ceiling or wall.

When you directly point the flash at subjects such as people, dark shadows may appear and skin color etc. may turn white. In this case, use bounce flash to soften the shadows and take natural pictures.

1 Press [OPEN] (A) lightly and then fix the built-in flash to the position illustrated below.

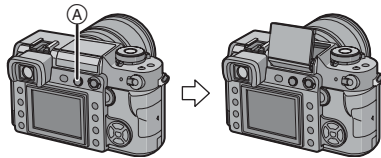

- The built-in flash is fixed at about 73°.
- You can also switch the flash from the normal flash position to the bounce flash position by pressing the flash down until it locks into the bounce flash position. (P58)

2 Aim the flash at a ceiling or other reflective surface and take a picture.

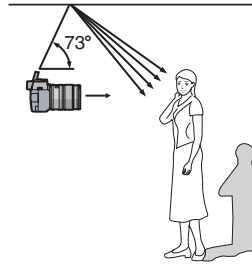

- Select a whitish ceiling with a high reflection ratio. If there are colors and patterns on the reflective surface, they will affect the color of the picture.
- The available flash range is less than when taking pictures with the flash normally.
- The reflected light may not reach the subject if the ceiling used for reflecting the light is too high.
- Using the flash for bounce flash at a position other than specified may cause a malfunction.

Fixing the Focus and the Exposure (AF/AE Lock)

This is useful when you want to take a picture of a subject outside the AF frame or the contrast is too strong and you cannot achieve appropriate exposure.

1 Aim the AF frame at the subject.

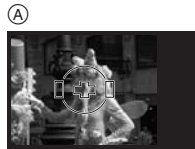

(A): Viewfinder Display

2 Press and hold [AFL/AEL] to fix the focus and the exposure.

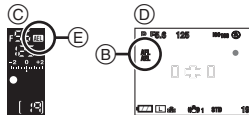
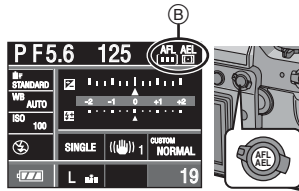

- (B): AF lock/AE lock indication
 (C): Viewfinder Display
 (D): When taking pictures with Live View
 (E): AE lock indication
- The focus indication, aperture value and the shutter speed light when the subject is focused and the exposure is set.
 - If you release [AFL/AEL], [AF/AE LOCK] is canceled.

3 While pressing [AFL/AEL], move the camera as you compose the picture and then press the shutter button fully.



(F): Viewfinder Display

■ Fixing the focus or the exposure only

1 Press [MENU/SET].

2 Press ▲/▼ to select [AF/AE LOCK] and then press ►.

3 Press ▲/▼ to select [AF] or [AE] and then press [MENU/SET].

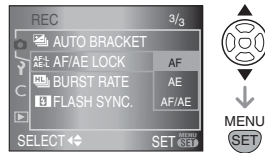

4 Press [MENU/SET] to close the menu.

- You can also press the shutter button halfway to close the menu.

When [AF] is selected (Fixing the focus only)

- 1 Aim the AF frame at the subject.
- 2 Press and hold [AFL/AEL] to fix the focus.
 - The focus indication lights when the subject is focused.
 - If you release [AFL/AEL], [AF/AE LOCK] is canceled.
- 3 While pressing [AFL/AEL], move the camera as you compose the picture and then press the shutter button fully.

**When [AE] is selected
(Fixing the exposure only)**

- ❶ Fill the screen with the object that you want to take a picture of.
- ❷ Press and hold [AFL/AEL] to fix the exposure.
 - The aperture value and the shutter speed light when the exposure matches.
 - If you release [AFL/AEL], [AF/AE LOCK] is canceled.
- ❸ While pressing [AFL/AEL], move the camera as you compose the picture.
- ❹ Press the shutter button halfway to focus on the subject and then press it fully.



- If you set [AF/AE LOCK HOLD] in the [CUSTOM] menu to [ON], you can fix the focus and the exposure even if you release the [AFL/AEL] button after pressing it. (P86)
- AF Lock only is effective, when taking pictures with manual exposure. AE Lock only is effective when taking pictures in manual exposure mode. You cannot select [AF/AE LOCK].
- AE Lock only is effective when taking pictures with manual focus.

Taking Pictures using Burst Mode

1 Set the drive mode lever to [].

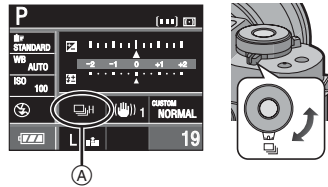

- Ⓐ: When burst mode is set to high speed [H].

2 Focus on the subject and take a picture.

- Hold down the shutter button fully to activate the burst mode.

■ Changing the burst speed

1 Press [MENU/SET].

2 Press ▲/▼ to select [BURST RATE] and then press ►.

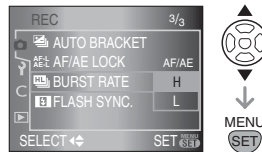

3 Press ▲/▼ to select [H] (High speed) or [L] (Low speed) and then press [MENU/SET].



4 Press [MENU/SET] to close the menu.

- You can also press the shutter button halfway to close the menu.

■ **Burst speed**

	 (High)	 (Low)
Burst speed (pictures/second)	3	2

- The burst speed is constant regardless of the transfer speed of the card.
- The burst speeds indicated are when the shutter speed is faster than 1/60 and the flash is not activated.
- The burst mode speed may become slower depending on the following settings.
 - ISO sensitivity (P71)
 - Picture size (P78)
 - Focus priority (P86)
 - Focus mode
- Since the shutter speed becomes slower in dark places, the burst speed (pictures/second) may become slower.

■ **Number of pictures recorded in burst mode**

	With RAW files	Without RAW files
Number of recordable pictures (pictures)	max. 6	Depends on the remaining capacity of the card

- Refer to P79 for information about RAW files.
- When there are no RAW files, pictures can be taken until the capacity of the card becomes full. However the burst speed will become slower halfway. The exact timing of this depends on the picture size, the setting for [QUALITY] and the type of card used.

■ **Focusing in burst mode**

The focus changes depending on the setting for [FOCUS PRIORITY] in the [CUSTOM] menu (P86) and the focus mode setting.

Focus	Focus mode	Focus Priority
The focus is fixed at the first picture*1	AFS	ON/OFF
The camera is continuously focusing on the subject*2	AFC	ON
The burst speed (High speed) stays constant	AFS/AFC/MF	OFF

- *1 When you take pictures using Live View, the focus mode setting is [AFS] and the focus is fixed at the first picture.
- *2 The burst speed may become slower because the camera is continuously focusing on the subject.



- We recommend using the remote shutter (DMW-RSL1; optional) when you want to keep the shutter button pressed fully while taking pictures in burst mode. Refer to P107 for information about the remote shutter.
- The auto review function is activated regardless of the setting for auto review. (The picture is not enlarged.)
- When the flash is activated, you can take only 1 picture.

Taking Pictures using Auto Bracket

In this mode, up to 5 pictures are recorded in the selected exposure compensation range each time the shutter button is pressed.

You can select the picture with the desired exposure among different exposures.

1 Set the drive mode lever to [].

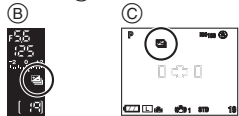
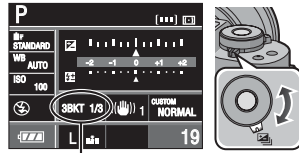

- Ⓐ: Auto Bracket (When [3/ 1/3 EV] is set)
- Ⓑ: Viewfinder Display
- Ⓒ: When taking pictures with Live View
 - [] is displayed on the Viewfinder. (It is displayed on the LCD monitor when taking pictures with Live View.)

2 Focus on the subject and take a picture.

- If you press and hold the shutter button, the number of pictures that you set is taken.
- The auto bracket indication blinks until the number of pictures that you set (3 or 5) is taken.
- The picture count is reset to [0] if you change the auto bracket setting, change the setting on the drive mode lever or turn the camera off before all the pictures that you set are taken.

Changing the settings for [NO./STEP] and [SEQUENCE] in auto bracket

1 Press [MENU/SET].

2 Press ▲/▼ to select [AUTO BRACKET] and then press ▶.

3 Press ▲/▼ to select [NO./STEP] or [SEQUENCE] and then press ▶.

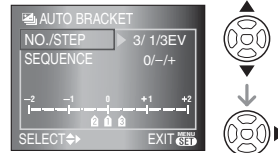

4 Press ▲/▼ to select the setting and then press [MENU/SET].

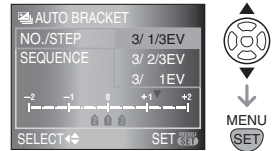

When [NO./STEP] has been selected in the screen shown in step 3

- [NO./STEP]
 - [3/ 1/3 EV]
 - [3/ 2/3 EV]
 - [3/ 1 EV]
 - [5/ 1/3 EV]
 - [5/ 2/3 EV]
 - [5/ 1 EV]

When [SEQUENCE] has been selected in the screen shown in step 3

- [SEQUENCE] (When taking 3 pictures)
 - [0/-/+]
 - [-/0/+]

- **[SEQUENCE]**

(When taking 5 pictures)

– [0/-/+/-/+]

(5 pictures are taken. The first picture is taken at 0 EV. The next 4 pictures are taken at –1 EV, +1 EV, –2 EV and then +2 EV.)

– [–/–/0/+]

(5 pictures are taken. The first picture is taken at –2 EV. The next 4 pictures are taken at –1 EV, 0 EV, +1 EV and then +2 EV)

5 Press [MENU/SET] twice to close the menu.

- You can also press the shutter button halfway to close the menu.



- When taking pictures using auto bracket after setting the exposure compensation range, the pictures taken are based on the selected exposure compensation range.
- The auto review function is activated regardless of the setting for auto review. (The picture is not enlarged.)
- The exposure may not be compensated with auto bracket depending on the brightness of the subject.
- You can only take 1 picture when the flash is activated. Also, you cannot take the number of pictures set in auto bracket if the number of recordable pictures is less.

Taking Pictures with the Self-timer

1 Set the drive mode lever to [Ⓢ].

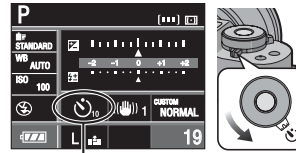

Ⓐ

Ⓐ: Self-timer set to [10 SEC.]

2 Focus on the subject and take a picture.

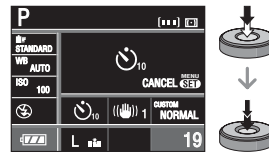

- A picture is not taken until the subject is brought into focus.
- If you want to press the shutter button fully to take a picture even when the subject is not focused, set [FOCUS PRIORITY] in the [CUSTOM] menu to [OFF]. (P86)

- The self-timer indicator Ⓑ blinks and the shutter is activated after 10 seconds (or 2 seconds).

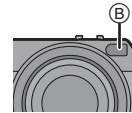

- If you press [MENU/SET] while taking a picture with the self-timer, it is canceled.

■ Changing the time setting for the self-timer

- 1 Press [MENU/SET].
- 2 Press ▲/▼ to select [SELF-TIMER] and then press ►.
- 3 Press ▲/▼ to select [10 SEC.] or [2 SEC.] and then press [MENU/SET].

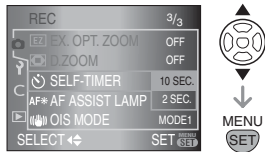

- 4 Press [MENU/SET] to close the menu.
 - You can also press the shutter button halfway to close the menu.



- When using a tripod etc., setting the self-timer to 2 seconds is a convenient way to avoid the jitter caused by pressing the shutter button.
- If you set [MIRROR UP] in the [CUSTOM] menu to [ON], you can prevent jitter (camera shake) caused by the mirror. (P87)
- We recommend using a tripod when taking pictures with the self-timer. (When you use a tripod, make sure the tripod is stable when the camera is attached to it.)

Adjusting the White Balance

This function allows you to reproduce a white color close to real life in pictures recorded under sunlight, halogen lighting etc. in which the white color may appear reddish or bluish. Select a setting that matches the recording conditions.

- 1 Press [WB] (A).

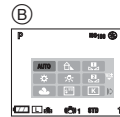
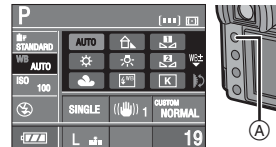

(B): When taking pictures with Live View

- 2 Rotate the command dial (C) to select the white balance.

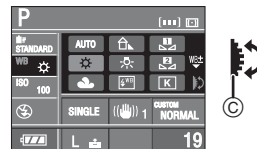

- 3 Press the shutter button halfway to set the selected white balance.

- You can also set the selected white balance by doing the following:
 - Pressing [WB]
 - Not operating the camera for a few seconds

[AUTO]	for auto setting (auto white balance)
[☀️] (Daylight)	for recording outdoors on a bright day
[☁️] (Cloudy)	for recording outdoors on a cloudy day
[🏠] (Shade)	for recording outdoors in the shade
[💡] (Halogen)	for recording under halogen lighting
[🔦] (Flash)	for recording with the flash only
[📺] (White set 1)	for using the preset white balance
[📺] (White set 2)	
[K] (Color temperature setting)	for using the preset color temperature setting

■ About the IR sensor [Ⓐ]

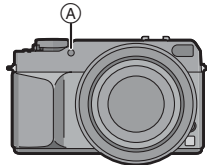

- If you select [AUTO], the IR sensor decides if the surrounding light is indoor light or sunlight and automatically sets an even more accurate white balance.

■ Auto white balance

The available white balance range is shown in the following illustration. When you take a picture beyond the available white balance range, the picture may appear reddish or bluish. Also, auto white balance may not operate properly if the subject is surrounded by many light sources. In these cases, adjust the white balance.

- 1 Auto white balance will work in the following range.
- 2 Blue sky
- 3 Cloudy sky (Rain)
- 4 Shade
- 5 TV screen
- 6 Sunlight
- 7 White fluorescent light
- 8 Incandescent light bulb
- 9 Sunrise and sunset
- 10 Candlelight

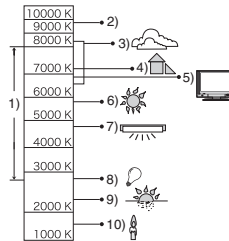

K=Kelvin Color Temperature



- You can finely adjust the white balance. (P70)
- We recommend setting the white balance to [AUTO] when taking pictures under fluorescent light.
- When you take a picture with the flash, the white balance may not be properly adjusted if the flash level is insufficient.

[WHITE SET] Resetting the white balance

Use this to set the white balance manually.

- 1 Select [**WB**] or [**WB2**] with step 2 on P68 and then press **▲**.

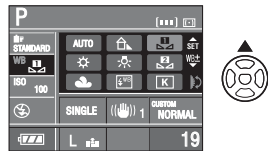

- 2 Aim the camera at a sheet of white paper, or an object that is white etc. so that the frame in the center is filled by the white object only and then press the shutter button fully.

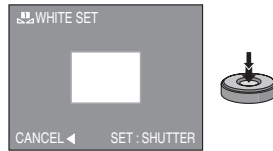

- You may not be able to set a new white balance if the subject is too bright or too dark. In this case, adjust the subject to an appropriate brightness and then reset the white balance.

[COLOR TEMPERATURE SETTING] Setting the color temperature

You can set the color temperature manually for taking natural pictures in different lighting conditions. The color of light is measured as a number in degrees Kelvin. As the color temperature becomes high the picture becomes bluish and as the color

temperature becomes low the picture becomes reddish. (P69)

- 1 Select [**K**] with step 2 on P68 and then press **▲**.

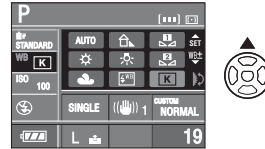

- 2 Rotate the command dial **(A)** to select [COLOR TEMPERATURE SETTING] and then press [MENU/SET].

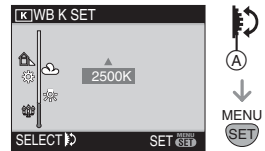

- You can set a color temperature from [2500 K] to [10000 K].

[WHITE BALANCE ADJUSTMENT] Finely adjusting the white balance

You can finely adjust the white balance when you cannot acquire the desired hue by setting the white balance.

- 1 Select the white balance with step 2 on P68 and then press **▼**.



2 Press ▲/▼/◀/▶ to finely adjust the white balance and then press [MENU/SET].

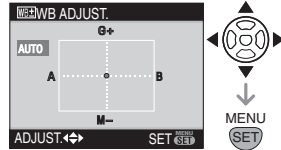

◀: A (AMBER: ORANGE TINT)

▶: B (BLUE: BLUISH)

▲: G+ (GREEN: GREENISH)

▼: M- (MAGENTA: REDDISH)

- If you finely adjust the white balance to A (amber), the white balance icon on the LCD monitor will change to orange.
- If you finely adjust the white balance to B (blue), the white balance icon on the LCD monitor will change to blue.
- If you finely adjust the white balance to G+ (green) or M- (magenta), [+] (green) or [-] (magenta) appears beside the white balance icon on the LCD monitor.
- Select the center point if you are not finely adjusting the white balance.



- You can finely adjust the white balance independently for each white balance item.
- The white balance fine adjustment setting is reflected in the picture when using the flash.
- The white balance fine adjustment setting is memorized even if the camera is turned off.
- The white balance fine adjustment level returns to the standard setting (center point) in the following cases.
 - When you reset the white balance in [WHITE SET] (P70) ([**W**]) or [**W**])
 - When you reset the color temperature manually in [COLOR TEMPERATURE SETTING] (P70) ([**K**])

Setting the Light Sensitivity

ISO is a measure of sensitivity to light. The higher the sensitivity is set, the less light is needed to take a picture so the camera becomes more suitable for recording in dark places.

1 Press [ISO] (A).

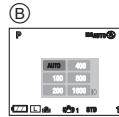
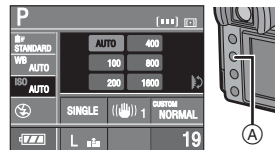

(B): When taking pictures with Live View

2 Rotate the command dial (C) to select the ISO sensitivity.

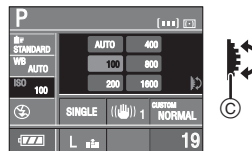

- When setting to [AUTO], the ISO sensitivity is automatically adjusted from [ISO100] to [ISO400] according to the brightness.

3 Press the shutter button halfway to set the selected ISO sensitivity.

- You can also set the selected ISO sensitivity by doing the following:
 - Pressing [ISO]
 - Not operating the camera for a few seconds

ISO sensitivity	100 ←————→ 1600	
Use in bright places (e.g. outdoors)	Suitable	Not suitable
Use in dark places	Not suitable	Suitable
Shutter speed	Slow	Fast
Noise	Less	Increased



- To avoid picture noise, we recommend reducing the ISO sensitivity before taking pictures.
- The ISO sensitivity cannot be set to [AUTO] in Aperture-priority AE, Shutter-priority AE or Manual exposure.

Deciding the Method to Measure Brightness (Metering mode)

You can switch to the following metering modes if you rotate the metering mode lever.

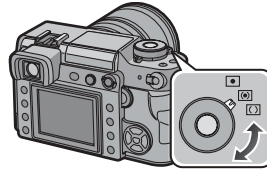

<input type="radio"/>	Spot: This is the method used to focus on the subject in the limited narrow area on the center of the screen.
<input checked="" type="radio"/>	Multiple: This is the method in which the camera measures the most suitable exposure by judging the allocation of brightness on the whole screen automatically. Usually, we recommend using this method.
<input type="radio"/>	Center weighted: This is the method used to focus on the subject on the center of the screen and measure the whole screen evenly.

Setting Frequently Used Functions

You can set two frequently used functions to the buttons [FUNC.1] and [FUNC.2]. This is convenient as you do not need to select the item from a menu.

- When you use a lens with no aperture ring, [FUNC.1] is fixed for aperture setting.

- 1 Press [FUNC.1] (A) or [FUNC.2] (B).
(when [PICT.SIZE] is set)

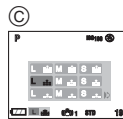
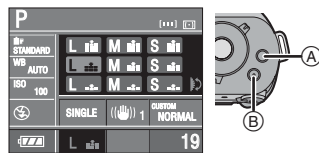

Ⓒ: When taking pictures with Live View

- 2 Rotate the command dial (D) to select an item.

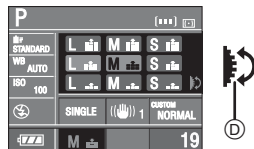

- 3 Press the shutter button halfway to set the selected item.

- You can also set the selected item by doing the following:
 - Pressing [FUNC.1] or [FUNC.2]
 - Not operating the camera for a few seconds

- Setting frequently used functions to the buttons [FUNC.1] and [FUNC.2]

- 1 Press [MENU/SET] and then press ◀.

- 2 Press ▼ to select the [CUSTOM] menu icon [C] and then press ▶.

- 3 Press ▲/▼ to select [FUNC.1 SET] or [FUNC.2 SET] and then press ▶.

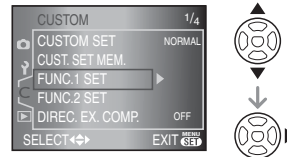



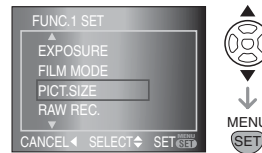













- 4 Press ▲/▼ to select the item and then press [MENU/SET].



- 5 Press [MENU/SET] to close the menu.

- You can also press the shutter button halfway to close the menu.
- You can also use the command dial when the instructions indicate to use ▲/▼.

■ **Functions that can be set to the buttons [FUNC.1] and [FUNC.2]**

- **[EXPOSURE]*1 (P40)**
 - [EXPOSURE]
- **[FILM MODE] (P76)**
 - STD [STANDARD]
 - DYN [DYNAMIC]
 - NATUR [NATURE]
 - SMOOTH [SMOOTH]
 -  STD [STANDARD]
 -  DYN [DYNAMIC]
 -  SMO [SMOOTH]
 - MY 1 [MY FILM1]
 - MY 2 [MY FILM2]
- **[PICT.SIZE]*2 (P78)**
 -  (L/Super Fine)
 -  (L/Fine)
 -  (L/Standard)
 -  (M/Super Fine)
 -  (M/Fine)
 -  (M/Standard)
 -  (S/Super Fine)
 -  (S/Fine)
 -  (S/Standard)
- **[RAW REC.] (P79)**
 - RAW ON
 - RAW OFF
- **[OIS MODE] (P82)**
 -  [MODE1]
 -  [MODE2]
- **[BURST RATE] (P64)**
 -  (High speed)
 -  (Low speed)
- **[FLASH SYNC.] (P83)**
 - [1ST] (1st curtain synchro)
 - [2ND] (2nd curtain synchro)
- **[CUSTOM SET] (P85)**
 - [NORMAL]
 - [FACTORY]
 - [SET 1]
 - [SET 2]
 - [SET 3]

*1 Set to [FUNC.2] at the time of purchase.

*2 Set to [FUNC.1] at the time of purchase.

If you set [EX. OPT. ZOOM] (P80) when taking pictures with Live View, [EZ] is displayed on the screen when the picture size is set to a size other than the maximum picture size for each aspect ratio.

Using the [REC] Mode Menu

Increase the variety of pictures you can take by setting color effect, picture adjustment etc.

- The following example shows how to set [D.ZOOM] when taking pictures with Live View. (Refer to P76 to P83 for each menu item.)
- Select [RESET] in the [SETUP] menu to return the menu settings to the initial settings at the time of purchase. (P29)

1 Press [MENU/SET].

2 Press ▲/▼ to select the menu item.

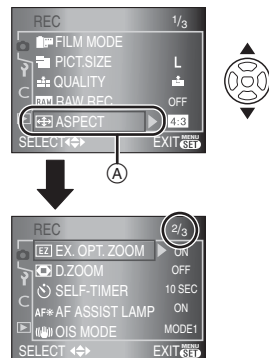

- Press ▼ at (A) to switch to the next menu screen.

3 Press ►, press ▲/▼ to select the setting and then press [MENU/SET].

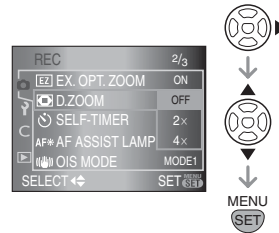

4 Press [MENU/SET] to close the menu.

- You can also press the shutter button halfway to close the menu.

■ About the menu screen items

- There are 3 menu screens in the [REC] menu (1/3, 2/3 and 3/3).

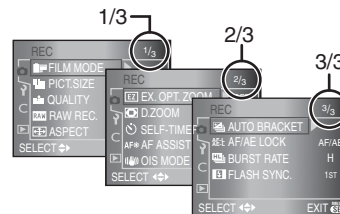

- You can also use the command dial when the instructions indicate to use ▲/▼.
- The next menu screen after 3/3 in the [REC] menu is the first menu screen in the [SETUP] menu.

[FILM MODE]
Setting the color tone of the picture to be recorded

Press [MENU/SET] to display the [REC] mode menu and select the item to set. (P75)
 Every type of film for film cameras has its own color tone and contrast characteristics. In film mode, you can select the color tone of the pictures from 7 types in the same way as you would select different films for film cameras.
 Select different settings in film mode to match the recording situation and your picture of the recording.

1 Press ▲/▼ to select [FILM MODE] and then press ►.

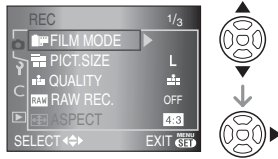

2 Press ▲/▼ to select the item and then press [MENU/SET].

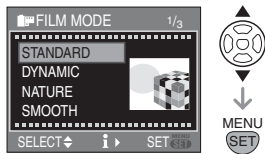

- When you press ► on the screen shown above, explanations about each film mode are displayed. (When you press ◀, the screen returns to the previous screen.)

3 Press [MENU/SET] to close the menu.

■ **Setting and effect**

- **[STANDARD] (COLOR)**
 This is the standard setting.
- **[DYNAMIC] (COLOR)**
 The saturation and contrast of the stored colors are increased.
- **[NATURE] (COLOR)**
 Brighter red, green and blue. Enhanced beauty of nature.
- **[SMOOTH] (COLOR)**
 The contrast is lowered for smoother and clearer color.
- **[STANDARD] B&W (B&W)**
 This is the standard setting.
- **[DYNAMIC] B&W (B&W)**
 The contrast is increased.
- **[SMOOTH] B&W (B&W)**
 Smooths the picture without losing the skin texture.
- **[MY FILM1]**
- **[MY FILM2]**
 The saved setting is used. (P87)



- In film mode, the camera may do something equivalent to pull processing to create a picture with particular characteristics. The shutter speed may become very slow at this time.

■ Adjusting each film mode to the desired setting

1 Press **▶** several times on the screen shown in step 2 on page 76.

2 Press **▲/▼** to select an item, use the command dial **(A)** to adjust it and then press **[MENU/SET]**.

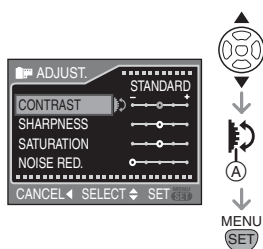

- The message [SAVE THIS SETTINGS?] appears.

3 Press **▲/▼** to select the item and then press **[MENU/SET]**.

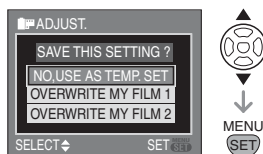

- You can save 2 user settings ([MY FILM1] and [MY FILM2]).
- [FILM MODE] is displayed as [TEMP.] on the LCD monitor if you select [NO, USE AS TEMP. SET]. The display disappears and the setting is canceled if the camera is turned off and then on again.

4 Press **[MENU/SET]** to close the menu.

[CONTRAST]	
[+]	Increases the difference between the brightness and the darkness in the picture.
[-]	Decreases the difference between the brightness and the darkness in the picture.

[SHARPNESS]	
[+]	The picture is sharply defined.
[-]	The picture is softly focused.

[SATURATION]	
[+]	The colors in the picture become vivid.
[-]	The colors in the picture become natural.

[NOISE RED.]	
[+]	The noise reduction effect is enhanced. Picture resolution may deteriorate slightly.
[-]	The noise reduction effect is reduced. You can obtain pictures with higher resolution.



- Noise may become visible when you take pictures in dark places. To avoid picture noise, we recommend setting [NOISE RED.] in [ADJUST.] towards [+] or setting the items except [NOISE RED.] towards [-] to take pictures.
- You cannot adjust [SATURATION] in the black and white settings in film mode.

[PICT.SIZE]/[QUALITY]
Setting a picture size and quality that match your use of the pictures

Press [MENU] to display the [REC] mode menu and select the item to set. (P75)
 A digital picture is made of numerous dots called pixels. Although you cannot see the difference on the camera's screen, the more the pixels the finer the picture will be when it is printed on a large piece of paper or displayed on a computer monitor. Picture quality refers to the compression rate when saving digital pictures.

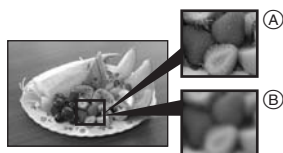

Ⓐ Many pixels (Fine)

Ⓑ Few pixels (Rough)

* **These pictures are examples to show the effect.**

■ **Number of pixels**

When you select a larger picture size [[L]] (7.4 million pixels), you can print pictures clearly.

If a small number of pixels [[S]] (3 million pixels) is selected, the size of the data will be small, so more pictures can be recorded.

- The number of pixels that can be selected differs depending on the aspect ratio. Refer to P79 for information about the aspect ratio settings.

■ **When the aspect ratio is [4:3].**

[L]	3136×2352 pixels (7.4 million pixels)
[M]	2560×1920 pixels (5 million pixels)
[S]	2048×1536 pixels (3 million pixels)

■ **When the aspect ratio is [3:2].
 (When taking pictures with Live View only)**

[L]	3136×2080 pixels (6.5 million pixels)
[M]	2560×1712 pixels (4.5 million pixels)
[S]	2048×1360 pixels (2.5 million pixels)

■ **When the aspect ratio is [16:9].
 (When taking pictures with Live View only)**

[L]	3136×1760 pixels (5.5 million pixels)
[S]	1920×1080 pixels (2 million pixels)

■ **Quality**

You can increase the number of recordable pictures without changing the picture size if quality is set to [Super Fine].

	Super Fine: Set this when recording the pictures with higher quality than that of Fine.
	Fine (Low compression): This gives priority to picture quality. Picture quality will be high.
	Standard (High compression): This gives priority to the number of recordable pictures. Standard quality pictures are recorded.



- If you set [EX. OPT. ZOOM] (P80) to [ON] when taking pictures with Live View, [EZ] is displayed on the screen when the picture size is set to a size other than the maximum picture size for each aspect ratio. "EZ" is an abbreviation of "Extended optical Zoom". (P80)
- Refer to P120 for information about the number of recordable pictures.

RAW [RAW REC.] Recording a RAW file simultaneously

Press [MENU] to display the [REC] mode menu and select the item to set. (P75)
When you take a picture, a RAW file is recorded simultaneously.

- When [ON] is set, a JPEG file and a RAW file are recorded simultaneously. The extension of a JPEG file and a RAW file is different as shown below.
 - JPEG file
[.JPG] (Example: P1000001.JPG)
 - RAW file
[.RAW] (Example: P1000001.RAW)
- When [OFF] is set, a RAW file is not recorded simultaneously.





- RAW files are recorded at the maximum picture size for each aspect ratio.
- The auto review function is activated regardless of the setting for auto review. (The image is not enlarged.)
- You can enjoy more advanced picture editing if you use RAW files. You can save RAW files in a file format (JPEG, TIFF etc.) that can be displayed on your PC etc., develop them and edit them using the software "SILKYPIX Developer Studio" by Ichikawa Soft Laboratory on the CD-ROM (supplied).



[ASPECT RATIO] Setting the aspect ratio of pictures (When taking pictures with Live View only)

Press [MENU] to display the [REC] mode menu and select the item to set. (P75)
By changing the aspect ratio, you can select an angle of view that matches the subject.

- Press [LIVE VIEW] to switch the camera beforehand to taking pictures with Live View. (P50)

4:3	<p>Select to take pictures with the same aspect ratio as a 4:3 TV or a computer monitor.</p> 
3:2	<p>Select to take pictures with the same 3:2 aspect ratio as 35 mm film.</p> 
16:9	<p>This is suitable for landscapes etc. where a wide view is preferable. This is also suitable for playing back pictures on a wide-screen TV, high-definition TV etc.</p> 



- The ends of the recorded pictures may be cut at printing. (P118) Check this before recording.

EZ [EX. OPT. ZOOM]
Enlarging a picture with no picture quality deterioration (When taking pictures with Live View only)

Press [MENU/SET] to display the [REC] mode menu and select the item to set. (P75)
 Normally you can take pictures with a maximum focal length of 50 mm (35 mm film camera equivalent: 100 mm) using the supplied lens.

However, if you set [EX. OPT. ZOOM] to [ON] when the picture size is set to a size other than the maximum picture size for each aspect ratio ([4:3] / [3:2] / [16:9]), a maximum focal length of 75 mm can be achieved (35 mm film camera equivalent: 150 mm) with no picture quality deterioration.

- Press [LIVE VIEW] to switch the camera beforehand to taking pictures with Live View. (P50)

■ Extended optical zoom mechanism

Example: When you set the picture size to [SEZ] (3 million pixels), the 7.4 million pixels CCD area is cropped to the center 3 million pixels area, allowing a picture with a higher zoom effect. (* is the equivalent value for a 35 mm film camera.)

This feature is displayed in grey when taking pictures with Viewfinder.

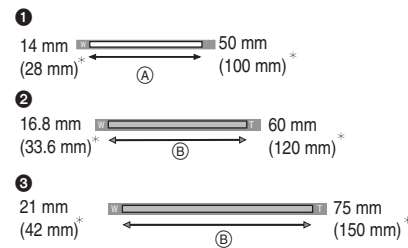

- 1. Extended optical zoom [OFF]
 Example: [S] (3 million pixels)
- 2. Extended optical zoom [ON]
 Example: [MEZ] (5 million pixels)

- 3. Extended optical zoom [ON]
 Example: [SEZ] (3 million pixels)
- (A): optical zoom
- (B): Extended optical zoom

■ Picture size and extended optical zoom magnification

Aspect ratio	Picture size	Extended optical zoom magnification	Focus range of the supplied lens
4:3	L (7.4 M)	Cannot set	14 mm to 50 mm (28 mm to 100 mm)*
3:2	L (6.5 M)		
16:9	L (5.5 M)		
4:3	MEZ (5M)	1.2×	16.8 mm to 60 mm (33.6 mm to 120 mm)*
3:2	MEZ (4.5M)		
4:3	SEZ (3M)	1.5×	21 mm to 75 mm (42 mm to 150 mm)*
3:2	SEZ (2.5M)		
16:9	SEZ (2M)		

* 35 mm film camera equivalent



- Refer to P79 for aspect ratio and P78 for picture size.
- “EZ” is an abbreviation of “Extended optical Zoom”.
- You can further enhance the zoom magnification with the extended optical zoom without worrying about further picture distortion.
- When [EX. OPT. ZOOM] is set to [ON], [EZ] is displayed on the screen if you set a picture size that activates the extended optical zoom.
- If you set [RAW REC.] to [ON], the extended optical zoom is not activated.

[D.ZOOM]**Further extending the zoom
(When taking pictures with
Live View only)**

Press [MENU] to display the [REC] mode menu and select the item to set. (P75)
You can further enhance the zoom magnification that you had when using the optical zoom (this includes when using the extended optical zoom), by 2× or 4× with the digital zoom.

You can take pictures with a maximum focal length of 200 mm (35 mm film camera equivalent: 400 mm) with the supplied lens. Also, if you set a picture size that activates the extended optical zoom, you can take pictures with a maximum focal length of 300 mm (35 mm film camera equivalent: 600 mm).

- Press [LIVE VIEW] to switch the camera beforehand to taking pictures with Live View. (P50)

- [OFF]:



- [2×]:

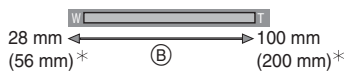

- [4×]:

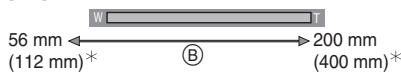

* 35 mm film camera equivalent

(A): Optical zoom

(B): Digital zoom

**Using the digital zoom together with
the extended optical zoom**

Example: When the digital zoom is set to [4×] and the picture size to [SEZ] (3 million pixels) you can use the extended optical zoom at the same time.



* 35 mm film camera equivalent

(C): Digital zoom and extended optical zoom



- In digital zoom, the larger the picture the lower the picture quality.
- When using the digital zoom, the stabilizer function may not be effective.
- When using the digital zoom, we recommend using a tripod and the self-timer (P67) for taking pictures.
- If you set [RAW REC.] to [ON], the digital zoom is not activated.

**[SELF-TIMER]****Setting the time for the
self-timer**

Press [MENU] to display the [REC] mode menu and select the item to set. (P75)

You can set the time for the self-timer to [10 SEC.] or [2 SEC.].

Refer to P67 for more information.

AF* [AF ASSIST LAMP]
Focusing in low light conditions becomes easier

Press [MENU] to display the [REC] mode menu and select the item to set. (P75)
 Illuminating the subject makes it easier for the camera to focus when recording in low light conditions that make focusing difficult.

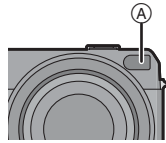

[ON]	If the AF assist lamp A is set to [ON], it turns on when you press the shutter button halfway in dark places etc. The effective range of the AF assist lamp is about 1.5 m (4.92 feet) to about 3.0 m (9.84 feet). (when the supplied lens is attached and at Wide)
[OFF]	The AF assist lamp does not turn on.



- Be careful about the following when using the AF assist lamp.
 - Do not look at the AF assist lamp from close up.
 - Do not attach the lens hood.
 - Do not cover the AF assist lamp with your fingers or other objects.
- When you do not want to use the AF assist lamp (e.g. when taking pictures of animals in dark places), set the [AF ASSIST LAMP] to [OFF]. In this case, it will become more difficult to focus on the subject.
- When you use a lens with a large filter diameter that obscures the AF assist lamp, shadows may appear on the picture and the performance of the camera may deteriorate.

[OIS MODE]
Optical Image Stabilizer

Press [MENU] to display the [REC] mode menu and select the item to set. (P75)
 This mode detects jitter and compensates for it.

- Check that the [O.I.S.] switch on the lens is set to [ON].

[MODE1] (1)	The stabilizer operates continuously and can assist during photo composition.
[MODE2] (2)	The jitter is compensated for when the shutter button is pressed. There is a greater stabilizing effect.



- The stabilizer function may not be effective in the following cases.
 - When there is a lot of jitter.
 - When the zoom magnification is high.
 - When using the digital zoom.
 - When taking pictures while following a moving subject.
 - When the shutter speed becomes slower to take pictures indoors or in dark places.
- Be careful of camera jitter when you press the shutter button.
- You cannot select [OIS MODE] if you use a lens with no stabilizer function.

[AUTO BRACKET] Taking Pictures using Auto Bracket

Press [] to display the [REC] mode menu and select the item to set. (P75)
In this mode, up to 5 pictures are recorded in the selected exposure compensation range each time the shutter button is pressed.

You can set the number of pictures recorded, the compensation range of the exposure and the bracket order.
Refer to P66 for more information.

[AF/AE LOCK] Switching the [AFL/AEL] button setting

Press [] to display the [REC] mode menu and select the item to set. (P75)
You can set [AFL/AEL] to [AF], [AE] or [AF/AE] if you want to fix the focus or the exposure when taking a picture.
Refer to P63 for more information.

[BURST RATE] Setting the burst speed

Press [] to display the [REC] mode menu and select the item to set. (P75)
You can set the burst speed to high speed [H] or low speed [L].
Refer to P64 for more information.

[FLASH SYNC.] Setting to the 2nd Curtain Synchro

Press [] to display the [REC] mode menu and select the item to set. (P75)
2nd curtain synchro activates the flash just before the shutter closes when taking pictures of moving objects such as cars using a slow shutter speed.

■ 1st curtain synchro





- The normal method when taking pictures with the flash.

■ 2nd curtain synchro



- The light source appears behind the subject and picture becomes dynamic.



- Set it to [1ST] normally.
- [2ND] is displayed in the flash icon on the LCD monitor if you set [FLASH SYNC.] to [2ND].
- The flash sync. settings are also effective when using an external flash. (P105)
- When a fast shutter speed is set, the effect of 2nd curtain synchro may deteriorate.
- You cannot set AUTO/Red-eye reduction [, Forced ON/Red-eye reduction [] or Slow sync./Red-eye reduction [] on the built-in flash when [FLASH SYNC.] is set to [2ND].

Using the [CUSTOM] Menu

You can change the settings for each function using the [CUSTOM] menu. You can then save these settings for future use. (P87)

- Set items as required. (Refer to P85 to P87 for each menu item.)
- The following example shows how to set [LCD AUTO].
- Select [RESET] in the [SETUP] menu to return the settings to the initial settings at the time of purchase. (P29)

1 Press [MENU/SET] and then press ◀.

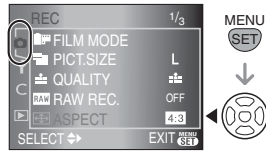

2 Press ▼ to select the [CUSTOM] menu icon [C] and then press ▶.

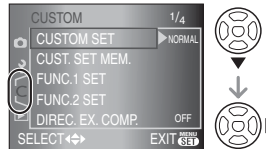

3 Press ▲/▼ to select the menu item.

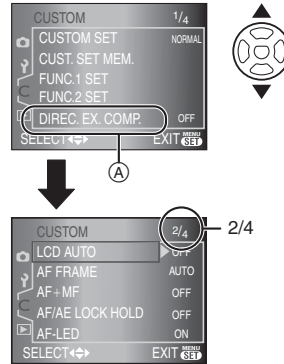

- Press ▼ at (A) to switch to the next menu screen.

4 Press ▶, press ▲/▼ to select the setting and then press [MENU/SET].

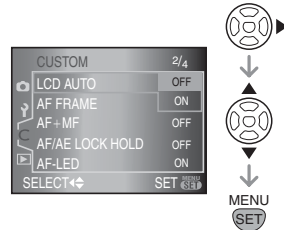

5 Press [MENU/SET] to close the menu.

- You can also press the shutter button halfway to close the menu.

■ About the menu screen items

- There are 4 menu screens in the [CUSTOM] menu (1/4, 2/4, 3/4 and 4/4).

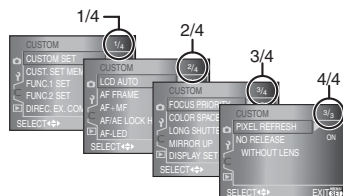

- You can also use the command dial when the instructions indicate to use ▲/▼, e.g. when selecting menu items.
- The next menu screen after 4/4 in the [CUSTOM] menu is the first menu screen in the [PLAY] mode menu.

[CUSTOM SET]

Press [MENU] to display the [CUSTOM] menu and select the item to set. (P84)

You can select the menu settings for the camera. (P87)

[NORMAL]:

The normal settings are selected.

[FACTORY]:

The settings at the time of purchase are temporarily selected due to a misoperation. (The folder number and the clock setting are not changed.)

[SET 1]: The settings saved in [CUSTOM SET 1] are selected.

[SET 2]: The settings saved in [CUSTOM SET 2] are selected.

[SET 3]: The settings saved in [CUSTOM SET 3] are selected.

- When you press ► at each menu item on the screen where you select menu items, all the settings for that menu item are displayed at a glance. (When you press ◀, the screen returns to the screen where you select menu items.)

[CUST. SET MEM.]

Press [MENU] to display the [CUSTOM] menu and select the item to set. (P84)

The current settings for the camera are saved as [CUSTOM SET 1], [CUSTOM SET 2] or [CUSTOM SET 3].

[FUNC.1 SET]

Press [MENU] to display the [CUSTOM] menu and select the item to set. (P84)

A function is set to the [FUNC.1] button.

[FUNC.2 SET]

A function is set to the [FUNC.2] button.

- Refer to P73 for information about [FUNC.1 SET] and [FUNC.2 SET].

[DIREC. EX. COMP.]

Press [MENU] to display the [CUSTOM] menu and select the item to set. (P84)

If you set [DIREC. EX. COMP.] to [ON], you can compensate the exposure by rotating the command dial only. (P38)

[ON]

[OFF]

[LCD AUTO]

Press [MENU] to display the [CUSTOM] menu and select the item to set. (P84)

If you set [ON] and take pictures with the Viewfinder, the LCD monitor turns off while the shutter button is pressed halfway etc.

[ON]

[OFF]

[AF FRAME]

Press [MENU] to display the [CUSTOM] menu and select the item to set. (P84)

Set the AF frame to the desired focus position.

- [AUTO]: The camera focuses on any of 3 focus area points- left, right or center. This is effective when the subject is not in the center of the screen.

[CENTER]:

The camera focuses on the subject in the AF frame on the center of the screen.

[SELECT]:

If you press ◀/▶, you can select the AF frame setting with Auto Focus-auto, left fix, center fix or right fix.

- If you set [AUTO], the focus position is not predetermined. It is set to a position automatically determined by the camera at the time of focusing. If you want to determine the focus position to take pictures, select a setting other than [AUTO].

[AF+MF]

Press [MENU] to display the [CUSTOM] menu and select the item to set. (P84)

If you set [ON], you can finely focus on the subject after it is automatically focused by rotating the focus ring.

[ON]

[OFF]

[AF/AE LOCK HOLD]

Press [MENU] to display the [CUSTOM] menu and select the item to set. (P84)

[ON]: The focus and the exposure remain fixed even if you release [AFL/AEL] after pressing it. If you press [AFL/AEL] again, [AF/AE LOCK] is cancelled.

[OFF]: The focus and the exposure are fixed only while you are pressing [AFL/AEL]. (P63)
If you release [AFL/AEL], [AF/AE LOCK] is cancelled.

[AF-LED]

Press [MENU] to display the [CUSTOM] menu and select the item to set. (P84)

If you set [ON], the lamp lights where the subject is focused in the AF frame on the Viewfinder. (P32)

[ON]

[OFF]

[FOCUS PRIORITY]

Press [MENU] to display the [CUSTOM] menu and select the item to set. (P84)

[ON]: You cannot take a picture until the subject is brought into focus.

[OFF]: This gives priority to the best time to take a picture so you can take a picture when the shutter button is pressed fully.

- If you set [OFF], be careful as the picture may not be properly focused even if [AFS] or [AFC] in focus mode is set.

[COLOR SPACE]

Press [MENU] to display the [CUSTOM] menu and select the item to set. (P84)

Set this when you want to correct the color reproduction of the recorded pictures on a PC, printer etc.

[sRGB]: Color space is set to sRGB color space.

This is widely used in computer related equipment.

[AdobeRGB]:

Color space is set to AdobeRGB color space.

AdobeRGB is mainly used for business purposes such as professional printing because it has a greater range of reproducible colors than sRGB.

- Depending on the color space setting, the file name of the recorded picture changes as shown.

P1000001.JPG

┌ P: sRGB
└ : AdobeRGB

- Set to sRGB if you are not very familiar with AdobeRGB.

[LONG SHUTTER NR]

Press [MENU/SET] to display the [CUSTOM] menu and select the item to set. (P84)

This removes picture noise when the shutter speed becomes slower to take pictures of night scenery etc.

If you set [ON], the countdown screen is displayed when the shutter button is pressed. Do not move the camera at this time. After the countdown is finished, [PLEASE WAIT...] is displayed for the same time as the selected shutter speed for signal processing.

If you press [MENU/SET] while taking a picture, the picture will not be taken.

[ON]
[OFF]

[MIRROR UP]

Press [MENU/SET] to display the [CUSTOM] menu and select the item to set. (P84)

You can prevent jitter (camera shake) caused by the mirror when the self-timer is set. (P67)

[ON]: The mirror goes up before the countdown starts. This prevents camera shake when the mirror rises.

[OFF]: After the countdown is finished, the mirror goes up at the same time the picture is taken.

[DISPLAY SET]

Press [MENU/SET] to display the [CUSTOM] menu and select the item to set. (P84)

Set the information to display on the LCD monitor when taking pictures with Live View. When you press [DISPLAY] to switch the information displayed on the LCD monitor, only the types of information set to [ON] are displayed.

[REC. INFO]: ON OFF
[HISTGRAM]: ON OFF
[GUIDE 1]: ON OFF
[GUIDE 2]: ON OFF

[PIXEL REFRESH]

Press [MENU/SET] to display the [CUSTOM] menu and select the item to set. (P84)

This checks if the picture on the image sensors and the picture after picture processing match each other optimally.

The camera is set to the best setting at the time of purchase. We recommend that you check the setting once every year.

Turn the camera off and on after the pixels are corrected.

[NO RELEASE WITHOUT LENS]

Press [MENU/SET] to display the [CUSTOM] menu and select the item to set. (P84)

If you set [ON], you cannot press the shutter button when a lens is not attached to the camera body or is not attached correctly. (Release prevention)

[ON]
[OFF]

Saving settings in [CUST. SET MEM.]

You can use custom set to save the current menu settings for the camera. You can save up to 3 menu settings in advance for future use.

Save the menu settings in advance and then select a menu setting that matches the recording situation etc. This is a convenient way to avoid resetting the menu settings each time you take a picture.

1 Press ▲/▼ to select

[CUST. SET MEM.] and then press ▶.

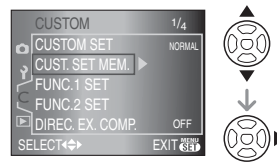

2 Press ▲/▼ to select [CUSTOM SET 1], [CUSTOM SET 2] or [CUSTOM SET 3] and then press [MENU/SET].

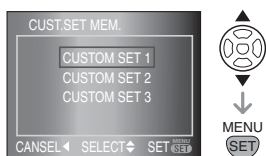

3 Press ▲ to select [YES] and then press [MENU/SET].
(Only when there are previously saved settings.)

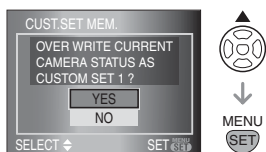

4 Press [MENU/SET] to close the menu.

■ **Using settings in [CUSTOM SET]**

Select the saved setting from [CUSTOM SET] in the [CUSTOM] menu. (P85)



- The settings for each menu item are not lost when the camera is turned off even if you do not use custom set to save them.

Using the [PLAY] mode menu

You can use various functions in playback mode to rotate pictures, set protection for them etc.

- Refer to P89 to 97 for each menu item.

1 Press [▶] to display a picture.

2 Press [MENU/SET].

3 Press ▲/▼ to select the menu item and then press ▶.

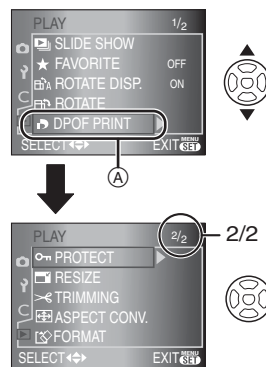

- Press ▼ at (A) to switch to the next menu screen.
- After performing steps 1 and 2, refer to the description of the menu item in the operating instructions and then set it.

■ About the menu screen items

- There are 2 menu screens in the [PLAY] mode menu (1/2 and 2/2).

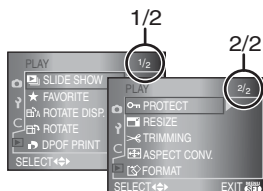

- You can also use the command dial when the instructions indicate to use ▲/▼, e.g. when selecting menu items.
- The next menu screen after 2/2 in the [PLAY] mode menu is the first menu screen in the [REC] menu.

[SLIDE SHOW]
Playing back pictures in order for a fixed duration

Press [MENU/SET] to display the [PLAY] mode menu and select the item to set. (P88)
This is recommended when playing back pictures on a TV screen. You can skip unwanted pictures if [FAVORITE] (P90) has been set.

- The screen shown in step 1 appears when [FAVORITE] is set to [ON]. When [FAVORITE] is set to [OFF], perform step 2 onwards.

1 Press ▲/▼ to select [ALL] or [★] and then press [MENU/SET].

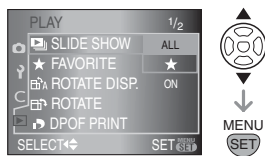

[ALL]	Displays all pictures.
[★]	Displays only those pictures that have been set as favorites (P90).

- If none of the pictures have [★] displayed, you cannot select [★] even if [FAVORITE] is set to [ON].

2 Press ▲ to select [START] and then press [MENU/SET].

(Screen when [ALL] is selected)

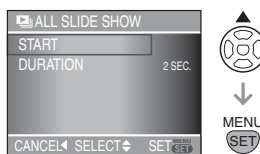

- The cursor displayed during a slide show (A) or while a slide show is paused (B) or during [MANUAL] slide show (C) is the same as ▲/▼/◀/▶.



- Press ▲ to pause the slide show. Press ▲ again to cancel pause.
- Press ◀/▶ while paused to display the previous or next picture.

3 Press ▼ to finish.

■ Setting duration

Select [DURATION] on the screen shown in step 2 and set.

[DURATION]	Can be set to [1 SEC.], [2 SEC.], [3 SEC.], [5 SEC.] or [MANUAL] (manual playback).
------------	---

- You can only select [MANUAL] when [★] has been selected in step 1.
- Press ◀/▶ to display the previous or next picture when [MANUAL] is selected.



- Power save mode is not activated during a slide show. (However, the setting for power save mode is fixed to [10 MIN.] while pausing a slide show or playing back a [MANUAL] slide show.)

★ [FAVORITE] Setting your favorite pictures

Press [MENU/SET] to display the [PLAY] mode menu and select the item to set. (P88)
You can do the following if a mark has been added to pictures and they have been set as favorites.

- Delete all the pictures not set as favorites. ([ALL DELETE EXCEPT ★]) (P46)
- Play back the pictures set as favorites only as a slide show. (P89)

1 Press ▼ to select [ON] and then press [MENU/SET].

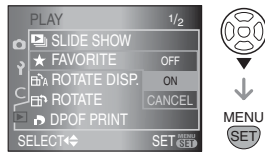

- You cannot set pictures as favorites if [FAVORITE] is set to [OFF]. Also the favorites icon [★] will not appear when [FAVORITE] is set to [OFF] even if it was previously set to [ON].
- You cannot select [CANCEL] if none of the pictures have [★] displayed.

2 Press [MENU/SET] to close the menu.

3 Press ◀▶ to select the picture and then press ▲.

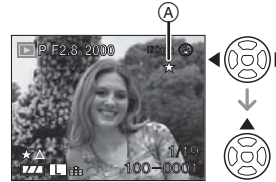

- Repeat the above procedure.
- If ▲ is pressed while the [★] favorites icon Ⓐ is displayed, [★] is cleared, and the favorites setting is canceled.
- You can set up to 999 pictures as favorites.

■ Deleting all favorites

- 1 Select [CANCEL] on the screen shown in step 1 and then press [MENU/SET].
- 2 Press ▲ to select [YES] and then press [MENU/SET].
- 3 Press [MENU/SET] to close the menu.



- When printing pictures at a photo printing store, [ALL DELETE EXCEPT ★] (P46) is useful so only the pictures you want to be printed remain on the card.
- Use [LUMIX Simple Viewer] or [PHOTOfunSTUDIO-viewer-] on the CD-ROM (supplied), to set, confirm or delete favorites. (For information about this, refer to the separate operating instructions for PC connection.)
- You may not be able to set pictures taken with other equipment as favorites.

[ROTATE DISP.]/[ROTATE]
To display the picture rotated

Press [MENU] to display the [PLAY] mode menu and select the item to set. (P88)
 This mode allows you to automatically display pictures vertically if they were recorded holding the camera vertically or rotate pictures manually in 90° steps.

■ **Rotate display (The picture is automatically rotated and displayed.)**

1 Press ▼ to select [ON] and then press [MENU/SET].

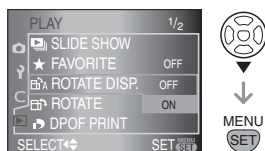

- The pictures are displayed without being rotated when you select [OFF].
- Refer to P44 for information about how to play back pictures.

2 Press [MENU/SET] to close the menu.



- Pictures recorded holding the camera vertically are automatically displayed vertically.

■ **Rotate**
 (The picture is rotated manually.)

1 Press ◀/▶ to select the picture and then press ▼.



- The [ROTATE] function is disabled when [ROTATE DISP.] is set to [OFF].
- Protected pictures cannot be rotated.

2 Press ▲/▼ to select the direction to rotate the picture and then press [MENU/SET].



↻	The picture rotates clockwise in steps of 90°.
↺	The picture rotates counter-clockwise in steps of 90°.

3 Press [MENU/SET] twice to close the menu.

■ **Example**
 When rotating clockwise (↻)

Original picture

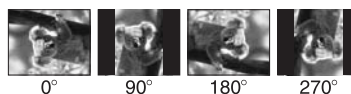



- When [ROTATE DISP.] is set to [ON], pictures recorded holding the camera vertically are played back vertically (rotated).
- If you take pictures when aiming the camera up or down, it may not be possible to display the pictures vertically. (P31)
- The picture may be slightly blurred when the camera is connected to the TV with the video cable (supplied) and played back vertically.
- When you play back pictures on a PC, they cannot be displayed in the rotated direction unless the OS or software is compatible with Exif. Exif is a file format for still pictures which allows recording information etc. to be added. It was established by "JEITA (Japan Electronics and Information Technology Industries Association)".
- Rotated pictures are displayed rotated when they are played back in review playback and playback zoom however are displayed without being rotated when they are played back in multi playback.
- It may not be possible to rotate pictures that have been recorded with other equipment.



[DPOF PRINT] Setting the picture to print and the number of prints

Press [MENU/SET] to display the [PLAY] mode menu and select the item to set. (P88)
DPOF "Digital Print Order Format" is a system that allows the user to select which pictures to print, how many copies of each picture to print and whether or not to print the recording date on the pictures when using a DPOF compatible photo printer or photo printing store. For details, ask at your photo printing store.

For more information visit:
http://panasonic.jp/dc/dpof_110/white_e.htm

92

VQT0W82

Press ▲/▼ to select [SINGLE], [MULTI] or [CANCEL] and then press [MENU/SET].

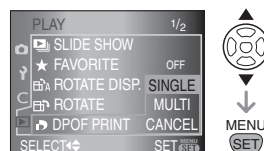

- You cannot select [CANCEL] if there are no prints that have been set in the DPOF print settings.

■ Single setting

1 Press ◀/▶ to select the picture to print and then press ▲/▼ to set the number of prints.



- The number of prints icon [] (A) appears.
- The number of prints can be set from 0 to 999. The DPOF print setting is canceled when the number of prints is set to [0].

2 Press [MENU/SET] twice to close the menu.

■ Multi setting

1 Press ◀/▶ to select the picture to print and then press ▲/▼ to set the number of prints.

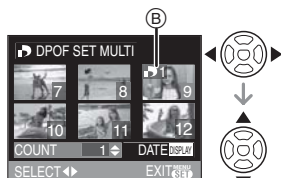

- The number of prints icon [] ② appears.
- Repeat the above procedure. (You cannot set all the pictures at one time.)
- The number of prints can be set from 0 to 999. The DPOF print setting is canceled when the number of prints is set to [0].

2 Press [MENU/SET] twice to close the menu.

■ To cancel all settings

1 Press ▲ to select [YES] and then press [MENU/SET].

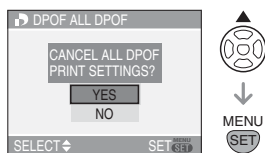

2 Press [MENU/SET] to close the menu.

■ To print the date

After setting the number of prints, set/cancel printing with the recording date by pressing [DISPLAY].

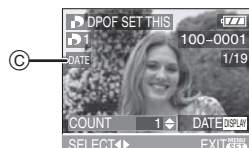

- The date print icon [DATE] ③ appears.
- When you go to a photo printing store for digital printing, be sure to order the printing of the date additionally if required.
- Depending on the photo printing store or the printer, the date may not be printed even if you set to print the date. For further information, ask at your photo printing store or refer to the operating instructions for the printer.



- DPOF is an abbreviation of “Digital Print Order Format”. This feature allows you to write print information to media and then use the information on a DPOF-compliant system.

- DPOF print setting is a convenient function when printing pictures with a printer that supports PictBridge (P100). The date printing setting on the printer may take priority over the date printing setting on the camera. Check the date printing setting on the printer also. (P100)
- It is necessary to delete all previous DPOF print information made on other equipment when setting DPOF print on the camera.

- If the file is not based on the DCF standard, the DPOF print setting cannot be set. DCF is an abbreviation of “Design rule for Camera File system”, stipulated by “JEITA (Japan Electronics and Information Technology Industries Association)”.

[MENU] **[PROTECT]**
Preventing accidental erasure of pictures

Press [**MENU**] to display the [PLAY] mode menu and select the item to set. (P88)
You can set protection for pictures you do not want to be deleted by mistake.

Press **▲/▼** to select [SINGLE], [MULTI] or [CANCEL] and then press [MENU/SET].

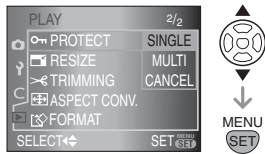

■ Single setting

1 Press **◀/▶** to select the picture and then press **▼** to set/cancel.



[SET]	The protect icon [PROTECT THIS] (A) appears.
[CANCEL]	The protect icon [PROTECT THIS] (A) disappears.

2 Press [MENU/SET] twice to close the menu.

■ Multi setting/To cancel all settings

Perform the same operation as in "[DPOF PRINT] Setting the picture to print and the number of prints". (P92 to 93)



- The protect setting may not be effective on other equipment.
- If you want to delete protected pictures, cancel their protection.
- Even if you protect pictures on a card, they will be deleted if the card is formatted. (P97)
- Even if you do not protect pictures on an SD Memory Card or an SDHC Memory card, they cannot be deleted when the card's Write Protect switch (C) is slid to the [LOCK] side.

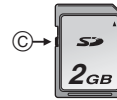

- Protected pictures cannot be rotated.

[MENU] **[RESIZE]**
Making the picture smaller

Press [**MENU**] to display the [PLAY] mode menu and select the item to set. (P88)
You can reduce the size of a recorded picture.

1 Press **◀/▶** to select the picture and then press **▼**.



- The following pictures cannot be resized.

Aspect Ratio	Picture Size
4:3	S
3:2	S
16:9	S

2 Press ◀/▶ to select the size and then press ▼.



- Sizes smaller than the recorded picture are displayed.

Aspect Ratio	Picture Size
4:3	M / S
3:2	M / S
16:9	S

- The message [DELETE ORIGINAL PICTURE?] appears.

3 Press ▲/▼ to select [YES] or [NO] and then press [MENU/SET].



- The picture is overwritten when you select [YES]. Resized pictures cannot be restored when they are overwritten.
- A resized picture is newly created when you select [NO].
- If the original picture is protected, you cannot overwrite it. Select [NO] and newly create a resized picture.

4 Press [MENU/SET] twice to close the menu.



- When you want to reduce the size of a picture to attach it to an e-mail or upload it to a website, use the software "PHOTOfunSTUDIO-viewer-" on the CD-ROM (supplied) to change the size.
- It may not be possible to resize pictures recorded with other equipment.

[TRIMMING] Enlarging a picture and trimming it

Press [MENU/SET] to display the [PLAY] mode menu and select the item to set. (P88)
You can enlarge and then clip the important part of the recorded picture.

1 Press ◀/▶ to select the picture and then press ▼.

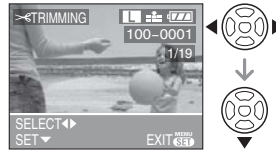

2 Enlarge or decrease the parts to be trimmed with the command dial (A).



3 Press ▲/▼/◀/▶ to move the position of the part to be trimmed.



4 Press shutter button.

- The message [DELETE ORIGINAL PICTURE?] appears.

5 Press ▲/▼ to select [YES] or [NO] and then press [MENU/SET].

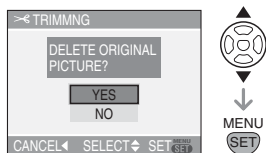

- The picture is overwritten when you select [YES]. The trimmed pictures cannot be restored when they are overwritten.
- A trimmed picture is newly created when you select [NO].
- When the original picture is protected, you cannot overwrite it. Select [NO] and newly create a trimmed picture.

6 Press [MENU/SET] twice to close the menu.



- Depending on the cut size, the picture size of the trimmed picture may become smaller than that of the original picture.
- The picture quality of the trimmed picture will deteriorate.
- It may not be possible to trim pictures recorded with other equipment.

[ASPECT CONV.]
Changing the aspect ratio of a 16:9 picture

Press [MENU] to display the [PLAY] mode menu and select the item to set. (P88)
You can convert pictures taken with a [16:9] aspect ratio to a [3:2] or a [4:3] aspect ratio for printing.

1 Press ▲/▼ to select [3:2] or [4:3] and then press [MENU/SET].

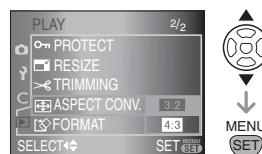

- Only pictures taken with a [16:9] aspect ratio can be converted.

2 Press ◀/▶ to select a picture and then press ▼.



- If you select and set a picture with an aspect ratio other than [16:9], the message [CANNOT BE SET ON THIS PICTURE] is displayed on the screen.

3 Press ◀/▶ to determine the horizontal position and then press the shutter button to set.



- Use ▲/▼ to set the frame position for pictures rotated vertically.
- The message [DELETE ORIGINAL PICTURE?] appears.

4 Press ▲/▼ to select [YES] or [NO] and then press [MENU/SET].

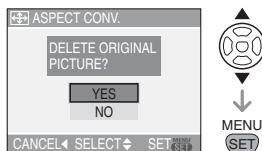

- The picture is overwritten when you select [YES]. If you convert the aspect ratio of a picture and then overwrite it, you cannot restore it.
- A picture with the converted aspect ratio is newly created when you select [NO].
- When the original picture is protected, you cannot overwrite it. Select [NO] and newly create a picture with the converted aspect ratio.

5 Press [MENU/SET] twice to close the menu.



- Files that do not conform to the DCF standard cannot be converted. DCF is an abbreviation of "Design rule for Camera File system", stipulated by JEITA "Japan Electronics and Information Technology Industries Association".
- You may not be able to convert pictures taken on other equipment.

[FORMAT] Initializing the card

Press [MENU] to display the [PLAY] mode menu and select the item to set. (P88)
It is not usually necessary to format a card. Format it when the message [MEMORY CARD ERROR] appears.

Press ▲ to select [YES] and then press [MENU/SET].

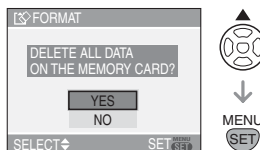

- Formatting irretrievably deletes all the data including any protected pictures. Check the data carefully before formatting.
- If the card has been formatted on a PC or other equipment, format it on the camera again.
- Use a sufficiently charged battery (P19) or the AC adaptor when formatting.
- Do not turn the camera off during formatting.
- You cannot format an SD Memory Card or an SDHC Memory Card when the card's Write-protect switch (C) is set to [LOCK].

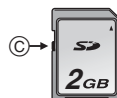

- If the card cannot be formatted, consult the customer call centers below.

For USA assistance, please call: 1-800-272-7033
or send e-mail to : digitalstillcam@panasonic.com

For Canadian assistance, please call:
1-800-561-5505 or visit us at www.panasonic.ca

Connecting to a PC

You can acquire recorded pictures to a PC by connecting the camera and the PC. The software [LUMIX Simple Viewer] or [PHOTOfunSTUDIO-viewer-] (for Windows®) on the CD-ROM (supplied) allows you to easily acquire pictures recorded with the camera to a PC, print them and send them by e-mail.

If you use “Windows 98/98SE”, install the USB driver and then connect it to the computer.

For information about installing [LUMIX Simple Viewer] or [PHOTOfunSTUDIO-viewer-] etc., refer to the separate operating instructions for PC connection.

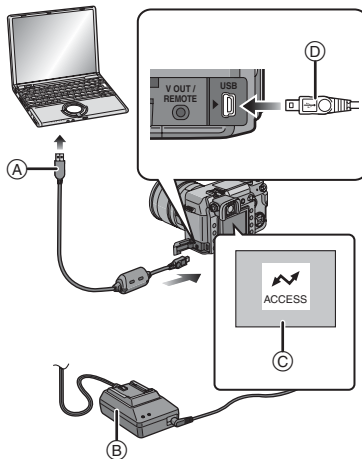

- Ⓐ: USB connection cable (supplied)
- Ⓑ: AC adaptor (supplied)
- Ⓒ: This message appears during data transfer.

- Use a sufficiently charged battery (P19) or the AC adaptor.
- Turn the camera off and then insert or remove the cable for the AC adaptor.

1 Turn on the camera and the PC.

2 Connect the camera to a PC via the USB connection cable (supplied).

- Align the [▶] mark on the USB connection cable and the [->•] mark on the terminal of the adaptor when connecting.
- Hold the USB connection cable at ① and insert straight in or take straight out. (If you forcibly insert the USB connection cable at a slant or upside down you can deform the connection terminals and damage the camera or the connected equipment.)

3 Press ▲ to select [PC] and then press [MENU/SET].

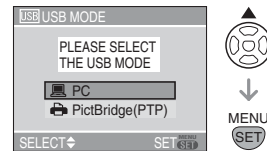

- If you set [USB MODE] in the [SETUP] menu to [PC] in advance, it is not necessary to set this every time you connect to a PC. (P29)
- If you set [USB MODE] to [PictBridge (PTP)] and then connect the camera to the PC, messages may appear on the screen of the PC. Select [CANCEL] to close the messages and disconnect the camera from the PC. Set [USB MODE] to [PC] again.

[Windows]

The drive appears in the [My Computer] folder.

- If you are connecting the camera to a PC for the first time, the required driver is installed automatically so that the camera can be recognized by “Windows Plug and Play”. The drive then appears on the [My Computer] folder.

[Macintosh]

The drive is displayed on the screen.

- The drive is displayed as [NO_NAME] or [Untitled].

■ Folder Composition

Folders are displayed as shown in the following illustration.

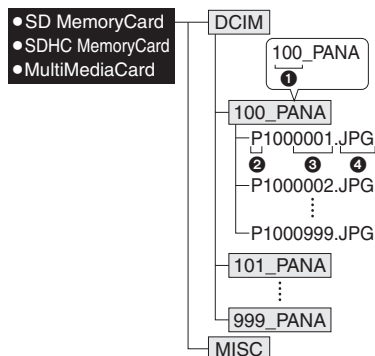

- ❶ Folder number
 - ❷ Color space
P: sRGB
_: AdobeRGB
 - ❸ File number
 - ❹ JPG: pictures
RAW: RAW files
- Refer to P79 for information about recording RAW files on this unit.

The items in each folder are as follows.

[DCIM]	Folders from [100_PANA] to [999_PANA]
[100_PANA] to [999_PANA]	Pictures/RAW files
[MISC]	Files on which the DPOF print settings are recorded

- The data for up to 999 pictures recorded by the camera can be included in 1 folder. If the number of pictures exceeds 999, another folder is created.

- To reset the file number or the folder number, select [NO.RESET] in the [SETUP] menu. (P29)

■ Conditions under which a different folder number is used

The picture is not recorded in the same folder as the previously recorded picture in the following cases. It is recorded in a folder with a new number.

- 1 When the folder just recorded contains a picture file with the number 999 in it (example: P1000999.JPG).
- 2 When the card just recorded to contains, for example, a folder with the number 100 [100_PANA] in it and that card is removed and replaced with a card that has a folder with the number 100 in it recorded by a camera from a different maker (100XXXXX, with XXXXX being the name of the maker) and then a picture is recorded.
- 3 When recording after selecting [NO.RESET] (P29) from the [SETUP] menu. (Pictures will be recorded to a new folder with a number sequential to the folder recorded to immediately before. By using [NO.RESET] on a card that does not contain folders or pictures, such as one just formatted, the folder number can be reset to 100.)

■ PictBridge (PTP) setting

Even if you set [USB MODE] to [PictBridge (PTP)], you can connect to your PC if the OS is "Windows XP Home Edition/Professional" or "Mac OS X".

- Pictures can only be read on the camera. They cannot be written to a card or deleted.
- When there are 1000 or more pictures on a card, the pictures may not be imported.



- Do not use any other USB connection cables except the supplied one.
- Do not disconnect the USB connection cable while [ACCESS] is displayed.
- If battery power is exhausted while the camera and the PC are communicating, the recorded data may be damaged. Use a battery with sufficient battery power (P19) or the AC adaptor.
- If the remaining battery power becomes low while the camera and the PC are communicating, the status indicator blinks and the alarm beeps. In this case, stop the communication at once on the PC.
- **When connecting the camera to a “Windows 2000” OS PC with the USB connection cable, do not replace the card while the camera and the PC are connected. The information on the card may be damaged. Disconnect the USB connection cable before replacing the card.**
- Be careful about the following when connecting the camera to a USB 2.0 (High Speed) compatible PC.
 - Operation is not guaranteed if you are connecting 2 or more USB products to a PC or connecting the camera with a USB Hub or a USB extension cable.
 - The camera may not operate normally if connected to the USB terminal on the keyboard.
- Pictures edited or rotated with a PC may be displayed in black in playback mode (P44), multi playback (P48) and calendar playback (P49).
- For information about this, refer to the separate operating instructions for PC connection.
- Read the operating instructions for the PC.

Printing the Pictures

By connecting the camera directly to a printer supporting PictBridge via the USB connection cable (supplied), you can select the pictures to print and start printing on the camera's screen.

Set print settings such as the print quality on the printer beforehand. (Read the printer operating instructions.)

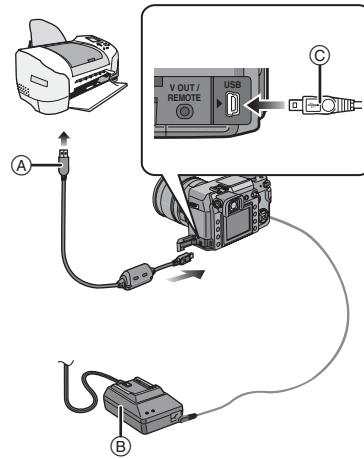

Ⓐ: USB connection cable (supplied)

Ⓑ: AC adaptor (supplied)

- It may take time to print the pictures so use a battery with sufficient battery power (P19) or the AC Adaptor when you connect to a printer.
- Turn the camera off and then insert or remove the cable for the AC Adaptor.

1 Turn on the camera and the printer.

2 Connect the camera to a printer via the USB connection cable (supplied).

- Align the [▶] mark on the USB connection cable and the [->•] mark on the terminal of the adaptor when connecting.
- Hold the USB connection cable at © and insert straight in or take straight out.

3 Press ▼ to select [PictBridge (PTP)] and then press [MENU/SET].

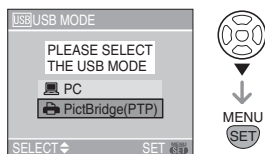

- If you set [USB MODE] in the [SETUP] menu to [PictBridge (PTP)] in advance, it is not necessary to set this every time you connect to a Printer. (P29)



- Do not use any other USB connection cables except the supplied one.

Single picture

1 Press ▲ to select [SINGLE PICTURE] and then press [MENU/SET].

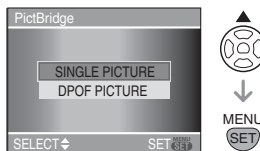

2 Press ◀▶ to select the picture and then press ▼.

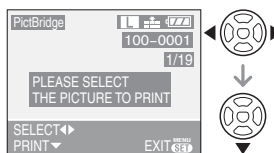

- The message disappears in about 2 seconds.

3 Press ▲ to select [PRINT START] and then press [MENU/SET].

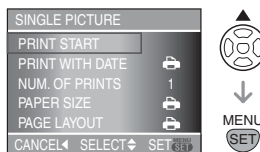

- Press [MENU/SET] to cancel printing.

4 Disconnect the USB connection cable after printing.

■ Setting date printing, the number of prints, the paper size and the page layout

Select and set each item in step **3**.

- Items not supported by the printer are displayed in gray and cannot be selected.
- When you want to print pictures in a paper size or a layout which is not supported by the camera, set [PAPER SIZE] or [PAGE LAYOUT] to [] and then set the paper size or the layout on the printer. (For details, refer to the operating instructions of the printer.)

[PRINT WITH DATE]

	Settings on the printer are prioritized.
[OFF]	Date is not printed.
[ON]	Date is printed.

- If the printer does not support date printing, the date cannot be printed on the picture.

[NUM. OF PRINTS]

Set the number of prints.

[PAPER SIZE]

(Paper sizes that can be set with this unit)





The paper sizes are displayed on pages 1/2 and 2/2. Press ▼ to select.

1/2	
	Settings on the printer are prioritized.
[L/3.5"×5"]	89 mm×127 mm
[2L/5"×7"]	127 mm×178 mm
[POSTCARD]	100 mm×148 mm
[A4]	210 mm×297 mm
2/2*	
[CARD SIZE]	54 mm×85.6 mm
[10×15cm]	100 mm×150 mm
[4"×6"]	101.6 mm×152.4 mm
[8"×10"]	203.2 mm×254 mm
[LETTER]	216 mm×279.4 mm

- * These items cannot be displayed when the printer does not support the paper sizes.

[PAGE LAYOUT]

(Layouts for printing that can be set with this unit)

	Settings on the printer are prioritized.
	1 photo/page
	1 photo/page
	2 photos/page
	4 photos/page

- An item cannot be selected if the printer does not support the page layout.

■ DPOF picture

- Set the DPOF print setting on the camera in advance. (P92)

1 Press ▼ to select [DPOF PICTURE] and then press [MENU/SET].

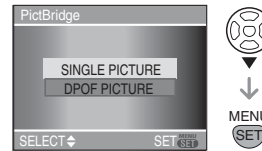

2 Press ▲ to select [PRINT START] and then press [MENU/SET].

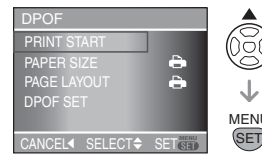

- You cannot select [PRINT START] when the DPOF print setting is not set. Select [DPOF SET] and then set the DPOF print setting. (P92)
- Press [MENU/SET] to cancel printing.

3 Disconnect the USB connection cable after printing.

■ Setting the date printing with the DPOF print in advance

We recommend setting DPOF date printing with [DPOF PRINT] (P93) in advance when the printer supports it. If you select [DPOF PICTURE], printing starts and the recording date is printed.

■ Layout printing

• When printing a picture several times on 1 sheet of paper

For example, if you want to print a picture 4 times on 1 sheet of paper, set [PAGE LAYOUT] to [4] and then set [NUM. OF PRINTS] to 4.

• When printing different pictures on 1 sheet of paper (only in DPOF printing)

For example, if you want to print 4 different pictures on 1 sheet of paper, set [PAGE LAYOUT] to [4] and then set [COUNT] in [DPOF PRINT] (P92) to 1 for each of the 4 pictures.



- Do not disconnect the USB connection cable when the cable disconnection warning icon [⚡] is displayed. (Depending on the printer, the icon may not be displayed.)
- If the remaining battery power becomes low while the camera and the printer are connected, the status indicator blinks and the alarm beeps. If this happens during printing, press [MENU/SET] and stop printing at once. If not printing, disconnect the USB connection cable.
- The camera is receiving an error message from the printer when the [●] indication lights orange during printing. After finishing printing, make sure there are no problems with the printer.
- If the total number of DPOF prints or the number of DPOF pictures printed is high, pictures may be printed several times. The remaining number of prints indicated may differ from the number set. This is not a malfunction.
- With date printing, the setting on the printer may take priority over the setting on the camera. Check the date print setting on the printer also.
- If the printer does not support RAW printing, the JPEG picture recorded simultaneously is printed. If no JPEG picture was recorded simultaneously, printing may not be possible.

Playing Back Pictures on a TV Screen

■ Playing back pictures using the Video cable (supplied)

- Set the aspect of the TV on the camera. (P30)
- Turn the camera and the TV off.

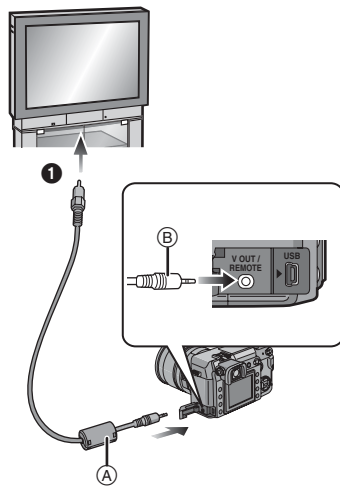

1 Connect the video cable (A) to the [V OUT/REMOTE] socket on the camera.

- Hold the video cable at (B) and insert straight in or take straight out.

2 Connect the video cable to the video input socket on the TV.

- ① Yellow: to the video input socket

3 Turn the TV on and select external input.

4 Turn the camera on and then press [▶].



- Do not use any other video cables except the supplied one.
- The top and bottom or left and right of the picture may be cut off slightly when it is displayed due to the characteristics of the TV.
- Depending on the screen mode setting of the TV when you connect the camera to a wide-screen TV or a high-definition TV, the picture may be stretched horizontally or vertically and the top and bottom or left and right of the picture may be cut off when it is displayed. In this case, change the screen mode setting.
- Read the operating instructions for the TV.
- When you play back a picture vertically, it may be blurry.
- You can view pictures on TVs in other countries (regions) which use the NTSC or PAL system when you set [VIDEO OUT] in the [SETUP] menu. Even if you set [VIDEO OUT] to [PAL], the output signal will still be [NTSC] in the recording mode.

■ Playing back pictures on a TV with an SD Memory Card slot

Still pictures recorded on an SD Memory Card or an SDHC Memory Card can be played back on a TV with an SD Memory Card slot.



- You cannot play back an SDHC Memory Card if the TV does not support it.
- Depending on the TV model, pictures may not be displayed on the full screen.
- You may not be able to play back MultiMediaCards.

Using the External Flash

If you use an external flash, the available flash range increases compared to the camera's built in flash.

■ Using the dedicated flash (DMW-FL500; optional)

1 Attach the dedicated flash to the hot shoe (A) and then turn on the camera and the dedicated flash.

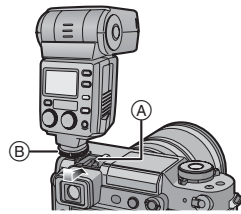

- Be sure to firmly secure to the dedicated flash with the lock ring (B).

2 Press [] (C).

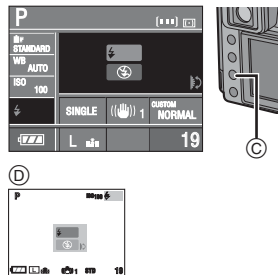

- ⓐ: When taking pictures with Live View

3 Rotate the command dial (E) to switch the flash settings.

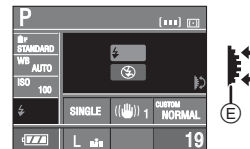

Icon	Setting
	External flash Forced ON
	External flash Forced OFF

4 Press the shutter button halfway to set the selected flash setting.

- You can also set the selected flash setting by doing the following:
 - Pressing []
 - Not operating the camera for a few seconds

■ When using other commercially available external flashes without communication functions with the camera (DMC-L1)

- It is necessary to set the exposure on the external flash. If you want to use the external flash in auto mode, use an external flash that allows you to set the aperture value and the ISO sensitivity to match the settings on the camera.
- Set to Aperture-priority AE mode [A] or Manual exposure mode [M] on the camera and then set the same aperture value and ISO sensitivity on the external flash. (The exposure cannot be compensated adequately due to the change on the aperture value in shutter-priority AE mode [S] and the external flash cannot control the light adequately in AE mode [P] because the aperture value cannot be fixed.)



- You can set the aperture value, the shutter speed and the ISO sensitivity on the camera even when attaching the external flash.
- Some commercial external flashes have synchro terminals with high-voltage or reversed polarity. Using such external flashes may cause a malfunction or the camera may not operate normally. Be sure to use Panasonic's external flash (DMW-FL500).
- If you use commercially available external flashes with communication functions other than the dedicated one, they may not operate normally or they may be damaged. Do not use them.
- **Even if the external flash is turned off, the camera may enter the external flash mode when the external flash is attached. When you are not using the external flash, detach it or set it to Forced OFF.**
- When attaching the external flash, the built-in flash cannot be activated.
- Do not open the built-in flash when an external flash is attached.
- When attaching the external flash, the camera will become unstable.
- Detach the external flash when carrying the camera.
- When attaching the external flash, do not hold only the external flash because it may detach from the camera.
- If you use the external flash when the white balance is set to [] (Flash) finely adjust the white balance depending on the picture quality. (P68)
- If you take pictures close to the subject in Wide, the vignetting effect may appear on the bottom of the recorded picture.
- **Read the operating instructions of the external flash for details.**

Using the MC Protector/PL Filter

The MC protector (DMW-LMCH72; optional) is a transparent filter which affects neither the colors nor the amount of light, so it can always be used to protect the camera's lens. Also, the PL filter (DMW-LPL72; optional) reduces diffused light reflection so you can take pictures with increased contrast.

1 Detach the lens cap.

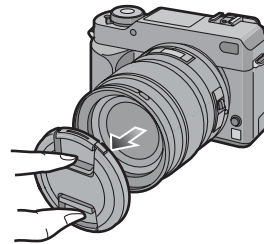

2 Attach the MC protector (A) or the PL filter (B).

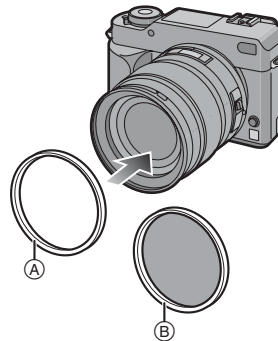



- You cannot attach the MC protector and the PL filter at the same time.
- If the MC protector/PL filter are tightened too much, you may not be able to remove them. Do not tighten them too much.
- When taking pictures with the flash using the MC protector or PL filter, vignetting effect may occur.
- If the MC protector/PL filter are dropped, they may be destroyed. Be careful not to drop them when attaching them to the camera.
- You can attach the lens cap or the lens hood when the MC Protector and the PL Filter are attached.
- Read the operating instructions of the MC protector or the PL filter for details.
- **MC**="Multi-coated"
PL="Polarizing lens filter"

Using the Remote Shutter

If you use the remote shutter (DMW-RSL1; optional), you can avoid jitter (camera shake) when using a tripod and you can keep the shutter pressed fully when taking pictures with [B] (Bulb) or burst mode. The remote shutter works similar to the shutter button on the camera.

- 1** Firmly connect the remote shutter to the [V OUT/REMOTE] socket on the camera as far as it will go.

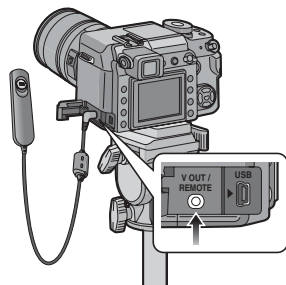

2 Take a picture.

- 1**: Press the button lightly to press halfway.
- 2**: Press the button fully to take the picture. (Press it as far as it will go.)

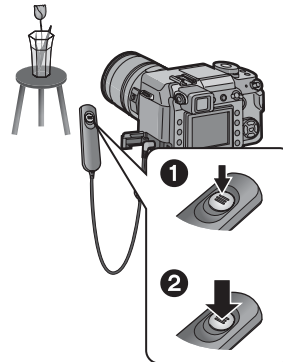

■ About [LOCK] on the remote shutter

- You can keep the shutter button pressed fully. This is effective when taking pictures with [B] (Bulb) (P39) or in burst mode (P64).
- While pressing the shutter button fully, slide it to the [LOCK] side.

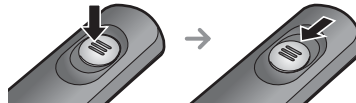

- Slide it to the other side to cancel [LOCK].



- Do not use any other remote shutters except DMW-RSL1 (optional).
- You cannot operate the camera with the remote shutter in the following cases.
 - When the power save mode is canceled
 - When you determine the part to be trimmed
 - When you determine the aspect ratio conversion

Displaying the Time at the Travel Destination (World Time)

If you set your home area and the travel destination area when traveling abroad etc., the local time at the travel destination area can be displayed on the screen and recorded on the pictures taken.

- Select [CLOCK SET] to set the current date and time in advance. (P26)

1 Press [MENU/SET] and then press ◀.

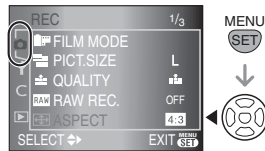

2 Press ▼ to select the [SETUP] menu icon [⌂] and then press ▶.

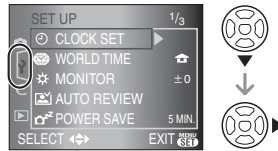

3 Press ▲/▼ to select [WORLD TIME] and then press ▶.

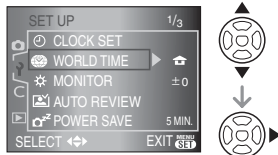

- If you are setting the world time for the first time, the message [PLEASE SET THE HOME AREA] appears. If this message appears, press [MENU/SET] and then set home area from the screen shown in step 2 in "Setting the home area [HOME]".

■ Setting the home area [HOME]

(Perform steps 1, 2 and 3.)

- 1 Press ▲/▼ to select [HOME] and then press [MENU/SET].



- 2 Press ◀/▶ to select your home area and then press [MENU/SET].

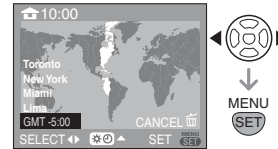

- The current time is displayed on the top left of the screen and the time difference from GMT "Greenwich Mean Time" is displayed on the bottom left of the screen.
- If daylight saving time [☀] is used at the home area, press ▲. Press ▲ again to return to the original time.
- The daylight saving time setting for the home area does not advance the current time. Advance the clock setting by one hour. (P26)

■ Finishing setting the home area

- If you are setting the home area for the first time, the screen returns to the screen shown in step ① of “Setting the home area [HOME]” after you press [MENU/SET] to set your home area. Press ◀ to return to the screen shown in step ③ and then press [MENU/SET] to close the menu.
- If you are setting the home area for the second time etc., the screen returns to the screen shown in step ③ after you press [MENU/SET] to set your home area. Press [MENU/SET] again to close the menu.

■ Setting the travel destination area (Perform steps ①, ② and ③.)

- ① Press ▲/▼ to select [DESTINATION] and then press [MENU/SET] to set.



- ① (A): Depending on the setting, the time at the travel destination area or the home area is displayed.

- If you are setting the travel destination area for the first time, the date and time are displayed as shown in the screen.
- ② Press ◀/▶ to select the area the travel destination is in and then press [MENU/SET] to set.

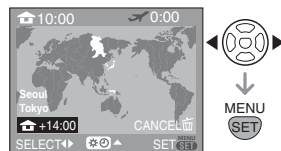

- The current time at the selected travel destination area is displayed on the top right of the screen and the time difference from the home area is displayed at the bottom left of the screen.
 - If daylight saving time [☀️] is used at the travel destination, press ▲. (The time advances by one hour.) Press ▲ again to return to the original time.
 - The names of major cities in the selected area are displayed. Also, the time difference between the selected area and the home area is displayed on the bottom left of the screen. (Refer to P110 for information about the names of the major cities that are displayed.)
- ③ Press [MENU/SET] to close the menu.



- The icon changes from [🏠] to [✈️] after setting the travel destination.



- Return the setting to [HOME] when the vacation is finished by performing steps ①, ②, ③ and then steps ① and ② of “Setting the home area [HOME]”.
- If you cannot find the travel destination in the areas displayed on the screen, set by the time difference from the home area.

Others

Location candidates for World Time settings				
Offset from GMT	Listed location name			
-11	Midway Islands	Samoa		
-10	Hawaii	Honolulu	Tahiti	
-9	Alaska	Anchorage		
-8	Vancouver	Seattle	Los Angeles	
-7	Denver	Phoenix		
-6	Chicago	Houston	Mexico City	
-5	Toronto	New York	Miami	Lima
-4	Caracas	Manaus	La Paz	
-3:30	Newfoundland			
-3	Rio de Janeiro	Sao Paulo	Buenos Aires	
-2	Fernando de Noronha			
-1	Azores			
0	London	Casablanca		
+1	Berlin	Paris	Rome	Madrid
+2	Helsinki	Athens	Cairo	Johannesburg
+3	Moscow	Kuwait	Riyadh	Nairobi
+3:30	Tehran			
+4	Dubai	Abu Dhabi		
+4:30	Kabul			
+5	Islamabad	Karachi	Male	
+5:30	Delhi	Kolkata	Mumbai	Chennai
+5:45	Kathmandu			
+6	Dacca	Colombo		
+6:30	Yangon			
+7	Bangkok	Jakarta		
+8	Beijing	Hong Kong	Kuala Lumpur	Singapore
+9	Tokyo	Seoul		
+9:30	Adelaide			
+10	Guam	Sydney		
+11	Solomon Islands	New Caledonia		
+12	Fiji	Auckland	Wellington	
+12:45	Chatham Islands			

* "GMT" is an abbreviation of "Greenwich Mean Time".

Cautions for Use

■ Optimal use of the camera

Take care not to drop or knock the unit or put a lot of pressure on it.

- Take care not to drop or knock the bag that you inserted the unit in as it may strongly shock the unit.
- A strong shock may break the lens, screen or outer case and cause the camera to malfunction.

Keep the camera as far away as possible from electromagnetic equipment (such as microwave ovens, TVs, video games etc.).

- If you use the camera on top of or near a TV, the pictures on the camera may be disrupted by electromagnetic wave radiation.
- Do not use the camera near cell phones because doing so may result in noise adversely affecting the pictures.
- Recorded data may be damaged, or pictures may be distorted, by strong magnetic fields created by speakers or large motors.
- Electromagnetic wave radiation generated by microprocessors may adversely affect the camera, disturbing the pictures.
- If the camera is adversely affected by electromagnetic equipment and stops functioning properly, turn the camera off and remove the battery or disconnect AC adaptor. Then reinsert the battery or reconnect AC adaptor and turn the camera on.

Do not use the camera near radio transmitters or high-voltage lines.

- If you record near radio transmitters or high-voltage lines, the recorded pictures may be adversely affected.

Always use the supplied cords and cables. If you use optional accessories, use the cords and the cables supplied with them.

Do not extend the cords or the cables.

Do not spray the camera with insecticides or volatile chemicals.

- If the camera is sprayed with such chemicals, the body of the camera may be damaged and the surface finish may peel off.
- Do not keep rubber or plastic products in contact with the camera for a long period of time.

Do not use benzine, thinner or alcohol for cleaning the camera.

- Remove the battery or disconnect the AC adaptor from the electrical outlet before wiping the camera.
- The body of the camera may be damaged and the surface finish may peel off.
- Wipe off any dust or fingerprints with a soft, dry cloth.
- Use a dry, dust cloth to remove dirt and dust on the zoom ring, focus ring and aperture ring.
- Do not use a kitchen detergent or a chemically treated cloth.
- The camera is not waterproof. If rain water or other drops of water splash onto the camera, wipe it with a dry cloth. If the camera does not operate normally, contact the dealer or your nearest servicenter.

About dirt on the image sensor

This camera features an interchangeable lens system so dirt may get inside the camera body when changing lenses. Depending on the recording conditions, dirt on the image sensor may appear on the recorded picture.

Do not change lenses where there is a lot of dust, and always attach the body cap when a lens is not attached to the camera, so that dirt or dust does not get inside the camera body. Remove any dirt on the body cap before attaching it.

Clean any dirt on the image sensor using the steps below.

Removing dirt on the image sensor

Black spots may appear on the recorded picture if dirt or dust gets on the image sensor. The image sensor is very delicate and easily scratched. If it becomes necessary to clean the image sensor, always use the following steps.

- Use the AC adaptor when cleaning. If you use the battery and the remaining battery power becomes low during cleaning, the shutter will close and the shutter curtains and the mirror may be damaged.

1 Detach the lens. (P16)

2 Turn the camera on.

3 Set [NO RELEASE WITHOUT LENS] in the [CUSTOM] menu to [OFF]. (P87)

4 Set the focus mode lever to [MF]. (P42)

5 Set the shutter speed to [B] (Bulb). (P39)

6 Press and hold the shutter button.

- The mirror goes up and the shutter curtains open.

7 Clean the image sensor.

- Blow off the dust on the surface of the image sensor with a commercially available blower brush. Be careful not to blow too strongly.
- Do not put the blower brush further inside than the lens mount.

- Do not let the blower brush touch the image sensor as the image sensor may get scratched.
- Do not use any objects except a blower brush to clean the image sensor.

8 Release the shutter button.

- The shutter curtains close and the mirror goes down when the camera is turned off. Be careful that the blower brush does not get caught in the shutter curtains.

9 Turn the camera off.

■ Battery

The battery is a rechargeable lithium ion battery.

Its ability to generate power comes from the chemical reaction that takes place inside it. This reaction is susceptible to the surrounding temperature and humidity. If the temperature is too high or too low, the operating time of the battery will become shorter.

After use, be sure to remove the battery.

Bring charged spare batteries when going out.

- Be aware that the operating time of the battery becomes shorter in low temperature conditions such as at a ski resort.
- When you travel, do not forget to bring the AC adaptor (supplied) so that you can charge the battery in the country that you are traveling in.

If you drop the battery accidentally, check to see if the body of the battery and the terminals are damaged.

- Inserting a damaged battery in the camera will damage the camera.

Dispose of unusable battery.

- Batteries have a limited life.
- Do not throw batteries into fire because it may cause an explosion.
- Unusable batteries should be discarded in accordance with battery recycling laws. Call the RBRC hotline at 1-800-822-8837 for information.

Do not allow battery terminals to come into contact with metal objects (such as necklaces, hairpins etc.).

- This can cause short circuiting or heat generation and you may be badly burned if you touch a battery.

■ AC adaptor

- If you use the AC adaptor near a radio, the radio reception may be disturbed. Keep the AC adaptor 1 m (3.28 feet) or more away from radios.
- When the AC adaptor is in use, it may generate whirring sounds. However, this is not a malfunction.
- After use, be sure to disconnect the AC cable from the electrical outlet. (A maximum of about 0.5 W is used if you leave it connected.)
- Keep the terminal of the AC adaptor clean.

■ Card

Do not leave the card where the temperature is high, where electromagnetic waves or static electricity are easily generated or exposed to direct sunlight.

Do not bend or drop the card.

- The card may be damaged or the recorded content may be damaged or deleted.
- Put the card in the card case or the storage bag after use and when storing or carrying the card.
- Do not allow dirt, dust or water to get into the terminals on the back of the card and do not touch the terminals with your fingers.

■ About the recorded data

- Recorded data may be damaged or lost if the camera breaks down due to inappropriate handling. Matsushita will not be liable for any damage suffered due to loss of recorded data.

■ About tripods

You can prevent jitter (camera shake) when the shutter speed is slow or you take a picture at close range if you use a commercially available tripod for cameras.

- When using a tripod, make sure it is stable when the camera is attached to it.
- You may not be able to remove the battery when using a tripod.
- Read the operating instructions for the tripod.

■ About the strap

- If you attach a heavy interchangeable lens (more than about 1 kg/35.3 oz) to the camera body, do not carry the camera by the strap. Hold the camera and the lens when carrying them.

Message Display

Confirmation messages or error messages will be displayed on the screen in some cases.

The major messages are described below as examples.

[THIS MEMORY CARD IS PROTECTED]

The Write-Protect switch on the SD Memory Card or the SDHC Memory Card is slid to the [LOCK] side. Slide it to the other side to unlock it. (P23, 94, 97)

[NO VALID PICTURE TO PLAY]

Record a picture or insert a card with a recorded picture and then play it.

[THIS PICTURE IS PROTECTED]

Delete or overwrite the picture after canceling the protect setting. (P94)

[THIS PICTURE CANNOT BE DELETED]/ [SOME PICTURES CANNOT BE DELETED]

Pictures not based on the DCF standard cannot be deleted. If you want to delete some pictures, format the card after saving necessary data on a PC etc. (P97)

[NO ADDITIONAL DELETE SELECTIONS CAN BE MADE]

You have exceeded the number of pictures that can be set at once with [MULTI DELETE]. Delete the selected pictures and then select [MULTI DELETE] again to delete any remaining pictures. More than 999 favorites have been set.

[CANNOT BE SET ON THIS PICTURE]/ [CANNOT BE SET ON SOME PICTURES]

If the pictures are not based on the DCF standard, the DPOF print cannot be set.

[MEMORY CARD ERROR FORMAT THIS CARD?]

The card format cannot be recognized by the camera. Format the card again with the camera after saving necessary data on a PC etc. (P97)

[PLEASE TURN CAMERA OFF AND THEN ON AGAIN]

Check that the lens is attached correctly and then turn the camera off and on.

[MEMORY CARD ERROR PLEASE CHECK THE CARD]

An error has occurred accessing the card. Insert the card again.

[READ ERROR PLEASE CHECK THE CARD]

An error has occurred reading the data. Insert the card again. Make sure the card is inserted properly and then play back again.

[WRITE ERROR PLEASE CHECK THE CARD]

An error has occurred writing the data. Turn the camera off and remove the card. Insert the card again and turn the camera on. Make sure the camera is turned off before removing or inserting the card to avoid damage.

[A FOLDER CANNOT BE CREATED]

A folder cannot be created because there are no remaining folder numbers that can be used. (P99)

Format the card after saving necessary data on a PC etc. (P97) If you execute [NO.RESET] in the [SETUP] menu after formatting, the folder number is reset to 100. (P29)

[PICTURE IS DISPLAYED FOR 4:3 TV]/ [PICTURE IS DISPLAYED FOR 16:9 TV]

- The video cable is connected to the camera. Press [MENU/SET] if you want to delete this message at once.
- Select [TV ASPECT] in the [SETUP] menu to change the TV aspect. (P30)

[CANCEL LIVE VIEW MODE]/[LIVE VIEW MODE CANNOT BE SELECTED]

If you use Live View where the temperature is high or for a long period of time, the temperature of the image sensor will increase and Live View may become unusable. Switch to using the Viewfinder for taking pictures or turn the camera off for a short while.

Troubleshooting

If you return the menu settings to the initial settings at the time of purchase, the condition may improve.

Select [RESET] in the [SETUP] menu. (P29)

■ Battery and power source

1: The camera cannot be operated even when it is turned on.

- Is the battery inserted correctly? Is the AC adaptor connected correctly?
- Is the battery sufficiently charged?
 - Charge the battery or use one that has been sufficiently charged.

2: The LCD monitor turns off while the camera is turned on.

The camera turns off arbitrarily.

- Is power save mode (P28) activated?
 - Press the shutter button halfway to cancel this mode.
- Is the battery exhausted?
 - Charge the battery or replace it with a battery which has enough capacity.

3: The camera turns off immediately after it is turned on.

- Is the battery charge insufficient to operate the camera?
 - Charge the battery or use one that has been sufficiently charged.
- If you leave the camera on, the battery will be exhausted. Turn the camera off frequently by using power save mode (P28) etc.

■ Recording

1: The picture cannot be recorded.

The shutter does not activate.

- Is the card inserted?
- Is there any memory remaining on the card?
 - Before recording, delete some pictures. (P45)
- Is the subject focused?
 - At the time of purchase, the camera is set so that you cannot take a picture until the subject is brought into focus. If you want to be able to take a picture when you press the shutter button fully even if the subject is not focused, set [FOCUS PRIORITY] in the [CUSTOM] menu to [OFF]. (P86)

2: The recording mode ([P], [A], [S], [M]) cannot be set correctly.

- Is the lens attached correctly?
 - Detach the lens and attach it again. (P16)

3: The subject is not focused properly.

- Is the subject beyond the focus range of the camera? (P34)
- Have you taken a picture with jitter?
- Is [FOCUS PRIORITY] in the [CUSTOM] menu set to [OFF]? (P86)
 - In this case, the picture may not be properly focused even if [AFS] or [AFC] in focus mode is set.

4: The recorded picture is whitish.

The lens is dirty.

- The picture can become whitish if there is dirt e.g. fingerprints on the lens. If the lens is dirty turn the camera off and then gently wipe the lens surface with a soft dry cloth.

5: The recorded picture is too bright or dark.

- Check that the exposure is correctly compensated. (P40)

6: The recorded picture is blurred. The optical image stabilizer is not effective.

- The shutter speed will become slower and the optical image stabilizer function may not work properly when taking pictures especially in dark places. In this case, we recommend holding the camera firmly with both hands when taking pictures (P31, 51). We recommend using a tripod and the self-timer (P67) when taking pictures with a slow shutter speed.

7: The recorded picture looks rough. Noise appears on the picture.

- Is the ISO sensitivity high or the shutter speed slow?
(ISO sensitivity is set to [AUTO] when the camera is shipped. Therefore, when taking pictures indoors etc. the ISO sensitivity increases.)
 - Decrease the ISO sensitivity. (P71)
 - Set [NOISE RED.] in [FILM MODE] towards [+] or set every item except [NOISE RED.] towards [–]. (P77)
 - Take pictures in bright places.
- Is [LONG SHUTTER NR] in the [CUSTOM] menu set to [OFF]? (P87)

8: The picture cannot be recorded with Live View.

- If you use Live View for a long period of time or where the temperature is high, the temperature of the image sensor will increase. A message may appear on the screen and Live View may become unusable. In this case, switch to using the viewfinder for taking pictures or turn the camera off for a short while.

9: A shutter sound is heard twice when taking pictures with Live View.

- If you press the shutter button fully, the shutter sound is heard twice and 1 picture is taken. The first shutter sound is heard when the shutter returns to the position before a picture is taken and the second shutter sound is heard when the picture is actually taken

10: The shutter sound is heard once when taking pictures with Live View however a picture is not taken.

- The shutter sound is heard in auto focus when the mirror goes down and then goes up after pressing the shutter button halfway to enable the camera to focus or when the shutter button is released immediately after pressing it fully. However a picture is not taken.

■ **LCD monitor/Viewfinder**

1: A flickering vertical line appears on the LCD monitor under fluorescent light.

High luminance light sources turn black.

If you move the camera quickly left and right when taking pictures, the dark parts of the subject may appear as if they have a purple or green afterimage.

- The LCD monitor may flicker for a few seconds after turning the camera on indoors under fluorescent light. This is not a malfunction. This does not affect the pictures you are recording.

2: The LCD monitor is too bright or dark.

- Adjust the brightness of the LCD monitor. (P28)
- Is the camera in High angle mode? (P53)

3: Black, red, blue and green dots appear on the LCD monitor.

- These pixels do not affect the recorded pictures. This is not a malfunction.

4: Noise appears on the LCD monitor.

- In dark places, noise may appear to maintain the brightness of the LCD monitor.
This does not affect the pictures you are recording.

■ Flash**1: The flash is not activated.**

- Is the flash closed?
– Press the [⚡ OPEN] button to open the flash. (P58)

2: The flash is activated 2 times.

- The flash is activated 2 times. The interval between the first and second flash is longer when AUTO/Red-eye reduction [⚡A], Forced ON/Red-eye reduction [⚡S] or Slow sync./Red-eye reduction [⚡S] is set so the subject should not move until the second flash is activated.

■ Playback**1: The picture being played back is rotated and displayed in an unexpected direction.**

The camera has a function that automatically rotates the display of pictures recorded holding the camera vertically. (If you take pictures when aiming the camera up or down, the camera may recognize that it is being held vertically.)

- You can display the pictures without being rotated when [ROTATE DISP.] (P91) is set to [OFF].
- You can rotate pictures with the [ROTATE] function. (P91)

2: The picture is not played back.

- Did you press [▶]?
- Is the card inserted?
- Is there a picture in the card?

3: The folder number and the file number are displayed as [-] and the screen turns black.

- Is the picture edited with a PC or recorded with a digital camera from another manufacturer?
This may happen if you remove the battery immediately after recording or you record with an exhausted battery.
– Format the data to delete the pictures mentioned above. (P97) (Formatting irretrievably deletes all data including the other pictures. Check the data carefully before formatting.)
- Pictures edited or rotated with a PC may be displayed in black in playback mode (P44), multi playback (P48) and calendar playback (P49).

4: The picture is displayed with a date different from the actual recording date in calendar playback.

- Was the picture edited with a PC or recorded with a digital camera from another manufacturer?
This kind of picture may be displayed with a date different from the actual recording date in calendar playback. (P49)
- Is the clock in the camera set properly? (P26)
For example, if the clock setting on the camera is different from the date and time set on the PC and you acquire pictures recorded with the camera to the PC and then write them back to the card, the pictures may be displayed with dates different from the actual recording dates in calendar playback etc.

■ **TV, PC and printer**

1: The picture does not appear on the television.

- Is the camera connected to the TV correctly?
- Set the TV input to external input mode.

2: The display areas on the TV screen and the camera's LCD monitor are different.

Depending on the TV model, the area display may be smaller so the picture may be stretched horizontally or vertically and the top and bottom or left and right of the picture may be cut off when it is displayed. This is due to the TV specifications and is not a malfunction.

3: The picture cannot be transferred when the camera is connected to a PC.

- Is the camera connected to the PC correctly?
- Is the camera recognized by the PC correctly?
- Set [USB MODE] to [PC]. (P29, 98)

4: The card is not recognized by the PC.

- Disconnect the USB connection cable. Connect it again while the card is inserted in the camera.

5: The picture cannot be printed when the camera is connected to a printer.

- Does the printer support PictBridge?
 - You cannot print pictures with printers which do not support PictBridge. (P100)
- Set [USB MODE] to [PictBridge (PTP)]. (P29, 100)

6: The ends of the pictures are cut at printing.

- When using a printer with a trimming or borderless printing function, cancel this function before printing. (For details, refer to the operating instructions for the printer.)
- Depending on the photo printing store, you may be able to print pictures in 16:9 size if they were recorded when the aspect ratio setting (P79) was [16:9]. Check with the photo printing store before printing.

7: The picture is not displayed fully on the TV.

- Check the [TV ASPECT] setting on the camera. (P30)

■ **Others**

1: An unreadable language was selected by mistake.

- Press [MENU/SET], select the [SETUP] menu icon [] and then select the [] icon to set the desired language. (P30)

2: A sound is heard when the camera is turned on or off.

This is the sound of lens or aperture movement and is not a malfunction.

3: A certain part of the picture appears blinking in black and white.

- Is [HIGHLIGHT] set to [ON]?
 - This appears due to the highlight feature function which shows white saturated areas. (P29)

4: The AF assist lamp does not turn on.

- Is [AF ASSIST LAMP] in the [REC] mode menu set to [ON]? (P82)
- Are you taking pictures in dark places?
 - The AF assist lamp does not turn on in bright places.

5: The camera becomes warm.

- The surface of the camera may become warm during use. This does not affect the performance or quality of the camera.

6: The clock is reset.

- If you do not use the camera for a long time, the clock may be reset. When the message [PLEASE SET THE CLOCK] appears, set the clock again. (P26)
- When you take a picture before setting the clock, [0:00 0. 0. 0] is recorded.

7: Colors appear on the picture which were not found in the actual scene.

- Depending on the zoom magnification, the picture may have some colored fringes around the subject. This is called chromatic aberration and may be more visible when recording distant subjects. However this is not a malfunction.

8: The file numbers are not recorded consecutively.

- When you perform an operation after taking a certain action, the pictures may be recorded in folders with different numbers from the ones used prior to the operation. (P99)

9: The file numbers are recorded in ascending order.

- If the battery is inserted or removed when the camera is not turned off, the recorded folder numbers are lost. However if you turn the camera on again and record pictures, the recorded folder numbers are different from the prior recorded folder numbers.

Number of recordable pictures

- The number of recordable pictures is an approximation. (These vary depending on the recording conditions and the type of card.)
- The number of recordable pictures depends on the subjects.
- The numbers in brackets are when [RAW REC.] is set to [ON].

Aspect ratio		4:3					
Picture size		L : 3136×2352 pixels (7.4M)			M : 2560×1920 pixels (5M EZ)		
Quality							
Card	16 MB	0 (0)	2 (0)	6 (0)	1 (0)	4 (0)	10 (0)
	32 MB	2 (0)	7 (1)	15 (1)	5 (1)	11 (1)	23 (1)
	64 MB	7 (2)	15 (3)	32 (3)	11 (2)	24 (3)	48 (3)
	128 MB	16 (5)	33 (6)	66 (7)	24 (6)	49 (7)	99 (7)
	256 MB	32 (10)	65 (12)	130 (14)	49 (12)	98 (13)	190 (14)
	512 MB	65 (21)	130 (25)	250 (28)	98 (24)	195 (27)	380 (29)
	1 GB	130 (43)	260 (51)	510 (57)	195 (48)	390 (55)	770 (59)
	2 GB	260 (88)	530 (105)	1040 (115)	400 (98)	790 (110)	1530 (120)
4 GB	530 (170)	1040 (200)	2040 (220)	790 (190)	1560 (220)	3010 (230)	

Aspect ratio		4:3			3:2		
Picture size		S : 2048×1536 pixels (3M EZ)			L : 3136×2080 pixels (6.5M)		
Quality							
Card	16 MB	3 (0)	7 (0)	16 (0)	1 (0)	3 (0)	7 (0)
	32 MB	8 (1)	17 (1)	35 (1)	3 (1)	8 (1)	17 (1)
	64 MB	18 (3)	37 (3)	74 (3)	8 (2)	17 (3)	36 (4)
	128 MB	38 (6)	77 (7)	150 (7)	18 (5)	37 (7)	74 (8)
	256 MB	76 (13)	150 (14)	290 (15)	36 (11)	74 (14)	145 (16)
	512 MB	150 (26)	300 (29)	590 (30)	74 (24)	145 (28)	290 (32)
	1 GB	300 (53)	600 (58)	1180 (61)	145 (48)	290 (58)	580 (64)
	2 GB	620 (105)	1220 (115)	2360 (120)	300 (99)	600 (115)	1180 (130)
4 GB	1230 (210)	2410 (230)	4640 (240)	590 (195)	1180 (230)	2310 (250)	

Aspect ratio		3:2					
Picture size		M : 2560×1712 pixels (4.5M EZ)			S : 2048×1360 pixels (2.5M EZ)		
Quality							
Card	16 MB	2 (0)	5 (0)	11 (0)	3 (0)	9 (0)	18 (0)
	32 MB	5 (1)	12 (1)	25 (2)	9 (1)	20 (1)	39 (2)
	64 MB	13 (3)	27 (3)	54 (4)	21 (3)	42 (4)	82 (4)
	128 MB	27 (6)	55 (7)	110 (8)	44 (7)	87 (8)	165 (8)
	256 MB	55 (13)	110 (15)	210 (16)	86 (14)	170 (16)	330 (17)
	512 MB	110 (27)	210 (31)	430 (33)	170 (29)	340 (32)	650 (34)
	1 GB	220 (54)	440 (62)	860 (66)	340 (59)	680 (65)	1310 (68)
	4 GB	880 (210)	1740 (240)	3350 (260)	1380 (230)	2680 (260)	5020 (270)

Aspect ratio		16:9					
Picture size		L : 3136×1760 pixels (5.5M):			S : 1920×1080 pixels (2M EZ)		
Quality							
Card	16 MB	1 (0)	4 (0)	9 (1)	5 (0)	12 (1)	24 (1)
	32 MB	4 (1)	9 (1)	20 (2)	13 (2)	27 (2)	52 (2)
	64 MB	10 (3)	21 (4)	43 (4)	28 (4)	56 (4)	105 (5)
	128 MB	21 (7)	44 (8)	88 (9)	58 (9)	115 (10)	220 (10)
	256 MB	43 (14)	87 (17)	170 (19)	115 (18)	220 (19)	430 (20)
	512 MB	87 (28)	170 (34)	340 (38)	230 (35)	440 (39)	860 (40)
	1 GB	175 (57)	350 (68)	690 (76)	460 (72)	900 (78)	1720 (81)
	4 GB	700 (220)	1380 (270)	2740 (300)	1820 (280)	3540 (310)	6700 (320)



- In some cases, the number of recordable pictures displayed on the Viewfinder*/LCD monitor may not decrease regularly.
- *You can display up to 99 pictures only on the Viewfinder.
- If you set [EX. OPT. ZOOM] (P80) to [ON] when taking pictures with Live View, [EZ] is displayed on the screen when the picture size is set to a size other than the maximum picture size for each aspect ratio.

Specifications

Digital Camera Body (DMC-L1):

Information for your safety

Power Source:	DC 8.4 V
Power Consumption:	2.2 W (When taking pictures with the Viewfinder) 3.8 W (When taking pictures with Live View) 2.2 W (When playing back)

Camera effective pixels:	7,500,000 pixels
Image sensor:	4/3" Live MOS sensor, total pixel number 7,940,000 pixels Primary color filter
Digital zoom:	Max. 4×
Extended optical zoom (Except for the maximum picture size for each aspect ratio):	ON/OFF simple enlargement (compatible with lenses from other manufacturers)
Focus:	3 points, AUTO/1 fixed point, right/1 fixed point, center/1 fixed point, left
Shutter System:	Focal-plane shutter
Burst recording	
Burst speed:	3 pictures/second (High speed), 2 pictures/second (Low speed)
Number of recordable pictures:	6 pictures (when there are RAW files) Depends on the capacity of the card (when there are no RAW files)
ISO sensitivity:	AUTO/100/200/400/800/1600
Shutter speed:	B (Bulb) (max. 8 minutes), 60 seconds to 1/4000th of a second
White balance:	AUTO/Daylight/Cloudy/Shade/Halogen/Flash/White set 1/ White set 2/Color temperature setting
Metering range:	EV 1 to EV 20 (When taking pictures with the Viewfinder)
Exposure (AE):	Program AE (P)/Aperture-priority AE (A)/ Shutter-priority AE (S)/Manual exposure (M) Exposure compensation (1/3 EV Step, -2 EV to +2 EV)
Metering mode:	Multiple/Center weighted/Spot
LCD monitor:	2.5" low-temperature polycrystalline TFT LCD (Approx. 207,000 pixels) (field of view ratio about 100%)
Viewfinder:	Optical SLR Viewfinder (Mirror) (field of view ratio about 95%) (with diopter adjustment -3 to +1 diopter)









Flash:	Built-in pop up flash Flash range: Approx. 2.5 m (8.2 feet) to 7.0 m (23.0 feet) (Supplied lens attached, Wide, When the ISO sensitivity is set to [AUTO].) AUTO, AUTO/Red-eye reduction, Forced ON, Forced ON/Red-eye reduction, Slow sync., Slow sync./Red-eye reduction, Forced OFF
Flash synchronization speed:	Equal to or smaller than 1/160th of a second
Recording media:	SD Memory Card/SDHC Memory Card/MultiMediaCard
Picture size	
Still picture:	When the aspect ratio setting is [4:3] 3136×2352 pixels, 2560×1920 pixels, 2048×1536 pixels When the aspect ratio setting is [3:2] 3136×2080 pixels, 2560×1712 pixels, 2048×1360 pixels When the aspect ratio setting is [16:9] 3136×1760 pixels, 1920×1080 pixels
Quality:	Super Fine/Fine/Standard
Recording file format:	JPEG (based on "Design rule for Camera File system", based on "Exif 2.21" standard)/DPOF corresponding
Interface	
Digital:	"USB 2.0" (High Speed) corresponding
Analog video:	NTSC/PAL Composite (Switched by menu)
Terminal	
[USB]:	5 pin Mini USB
[V OUT/REMOTE]:	φ 2.5 mm jack
[DC IN]:	Dedicated DC cable
Dimensions:	Approx. 145.8 mm (W)×86.9 mm (H)×80 mm (D) [5 3/4" (W)×3 7/16" (H)×3 3/16" (D)] (excluding the projecting part)
Mass:	Approx. 530 g/18.7 oz (camera body), Approx. 1098 g/38.7 oz (with supplied lens, card and battery)
Operating temperature:	0 °C to 40 °C (32 °F to 104 °F)
Operating humidity:	10% to 80%
AC Adaptor	
(Panasonic DE-972A):	Information for your safety
Output:	DIGITAL CAMERA 8.4 V --- 1.2 A CHARGE 8.4 V --- 1.2 A
Input:	110 V to 240 V ~ 50/60 Hz, 0.3 A
Battery Pack (lithium-ion)	
(Panasonic CGR-S603A):	Information for your safety
Voltage/capacity:	7.2 V, 1500 mAh

Others

**Interchangeable Lens “LEICA D VARIO-ELMARIT 14–50 mm/F2.8–3.5”
(L-ES014050)**

Focal length	f=14 mm to 50 mm (35 mm film camera equivalent: 28 mm to 100 mm)
Aperture type	7 leaf shutters/iris diaphragm
Aperture range	F2.8 (Wide) to F3.5 (Tele)
Lens construction	16 elements in 12 groups (2 aspherical lenses)
In focus distance	0.29 m (0.95 feet) to ∞ (from the focus distance reference line)
Optical image stabilizer	Available
Mount	“Four Thirds Mount”
Max. diameter	78.1 mm (3.07 inch)
Overall length	Approx. 97.4 mm (3.83 inch) (from the tip of the lens to the base side of the lens mount)
Mass	Approx. 490 g (17.3 oz)

Digital Camera Accessory System

Accessory#	Figure	Description
CGR-S603A		Lithium Ion Battery
DMW-FL500		Flash
DMW-LMCH72		MC Protector
DMW-LPL72		PL Filter (Circular Type)
DMW-RSL1		Remote Shutter
DMW-BAL1		Leather Bag
DMW-SSTL1		Shoulder Strap
RP-SDR04GU1K RP-SDK02GU1A RP-SDR02GU1A RP-SDK01GU1A RP-SDH01GU1A RP-SDR01GU1A RP-SDK512U1A RP-SDR512U1A RP-SDH256U1A RP-SDR256U1A RP-SD128BU1A RP-SD064BPPA		4 GB SDHC Memory Card 2 GB SD Memory Card 2 GB SD Memory Card 1 GB SD Memory Card 1 GB SD Memory Card 1 GB SD Memory Card 1 GB SD Memory Card 512 MB SD Memory Card 512 MB SD Memory Card 256 MB SD Memory Card 256 MB SD Memory Card 128 MB SD Memory Card 64 MB SD Memory Card

- Refer to P19 for information about the battery charging time and the number of recordable pictures.
- NOTE: Accessories and/or model numbers may vary between countries. Consult your local dealer.

Others

Digital Camera Accessory Order Form (For USA Customers)

Please photocopy this form when placing an order.

1. Digital Camera Model # _____

2. Items Ordered

Accessory #	Description	Price Each	Quantity	Total Price
Subtotal				
Your State & Local Sales Tax				
Shipping & Handling				6.95
Total Enclosed				

3. Method of payment (check one)

- Check of Money Order enclosed (NO C.O.D.SHIPMENTS)
- VISA Credit Card # _____
- MasterCard Expiration Date _____
- Discover Customer Signature _____

Make Check or Money Order to: PANASONIC ACCESSORIES

(Please do not send cash)

4. Shipping information (UPS delivery requires complete street address)

Ship To:

Mr.

Mrs.

Ms.

First _____ Last _____

Phone#:

Day () _____

Street Address _____

Night () _____

City _____ State _____ Zip _____

TO OBTAIN ANY OF OUR DIGITAL CAMERA ACCESSORIES YOU CAN DO ANY OF THE FOLLOWING:

VISIT YOUR LOCAL PANASONIC DEALER

OR

CALL PANASONIC'S ACCESSORY ORDER LINE AT 1-800-332-5368

[6 AM-5 PM M-F, 6 AM-10:30 AM SAT, PACIFIC TIME]

OR

MAIL THIS ORDER TO: PANASONIC SERVICES COMPANY ACCESSORY ORDER OFFICE

20421 84th Avenue South Kent, WA. 98032

In CANADA, please contact your local Dealer for more information about accessories.

126

VQT0W82

Request for Service Notice (For USA Only)

Please photocopy this form when making a request for service notice.

In the unlikely event this product needs service.

Request for Service Notice: (USA Only)

- Please include your **proof of purchase.**
(Failure to do so will delay your repair.)
- To further speed your repair, please provide an explanation of what wrong with the unit and any symptom it is exhibiting.

Mail this completed form and your Proof of Purchase along with your unit to:
Panasonic Services Company
410B Airport Road
Elgin, IL 60123-9333
Attn: Digital Camera Repair

Limited Warranty (For USA Only)

PANASONIC CONSUMER ELECTRONICS COMPANY, DIVISION OF
PANASONIC CORPORATION OF NORTH AMERICA
One Panasonic Way, Secaucus, New Jersey 07094
PANASONIC PUERTO RICO, INC.
Ave. 65 de Infantería, Km. 9.5, San Gabriel Industrial Park, Carolina, Puerto
Rico 00985

Panasonic Digital Still Camera Limited Warranty

Limited Warranty Coverage

If your product does not work properly because of a defect in materials or workmanship, Panasonic Consumer Electronics Company or Panasonic Puerto Rico, Inc. (collectively referred to as "the warrantor") will, for the length of the period indicated on the chart below, which starts with the date of original purchase ("warranty period"), at its option either (a) repair your product with new or refurbished parts, or (b) replace it with a new or refurbished product. The decision to repair or replace will be made by the warrantor.

PRODUCT OR PART NAME	PARTS	LABOR
DIGITAL STILL CAMERA (EXCEPT ITEMS LISTED BELOW)	1 (ONE) YEAR	90 (NINETY) DAYS
CCD	6 (SIX) MONTHS	90 (NINETY) DAYS
RECHARGEABLE BATTERY PACK (IN EXCHANGE FOR DEFECTIVE BATTERY PACK)	90 (NINETY) DAYS	NOT APPLICABLE
SD MEMORY CARD (IN EXCHANGE FOR DEFECTIVE SD CARD)	90 (NINETY) DAYS	NOT APPLICABLE

During the "Labor" warranty period there will be no charge for labor. During the "Parts" warranty period, there will be no charge for parts. You must carry-in or mail-in your product during the warranty period. If non-rechargeable batteries are included, they are not warranted. This warranty only applies to products purchased and serviced in the United States or Puerto Rico. This warranty is extended only to the original purchaser of a new product which was not sold "as is". A purchase receipt or other proof of the original purchase date is required for warranty service.

Carry-In or Mail-In Service

For Carry-In or Mail-In Service in the United States call
1-800-272-7033.

For assistance in Puerto Rico call Panasonic Puerto Rico, Inc.
(787)-750-4300 or fax (787)-768-2910.

This warranty ONLY COVERS failures due to defects in materials or workmanship, and DOES NOT COVER normal wear and tear or cosmetic damage. The warranty ALSO DOES NOT COVER damages which occurred in shipment, or failures which are caused by products not supplied by the warrantor, or failures which result from accidents, misuse, abuse, neglect, mishandling, misapplication, alteration, faulty installation, set-up adjustments, misadjustment of consumer controls, improper maintenance, power line surge, lightning damage, modification, or commercial use (such as in a hotel, office, restaurant, or other business), rental use of the product, service by anyone other than a Factory Servicenter or other Authorized Servicer, or damage that is attributable to acts of God.

THERE ARE NO EXPRESS WARRANTIES EXCEPT AS LISTED UNDER "LIMITED WARRANTY COVERAGE". THE WARRANTOR IS NOT LIABLE FOR INCIDENTAL OR CONSEQUENTIAL DAMAGES RESULTING FROM THE USE OF THIS PRODUCT, OR ARISING OUT OF ANY BREACH OF THIS WARRANTY. (As examples, this excludes damages for lost time, travel to and from the servicer, loss of media or images, data or other memory content. The items listed are not exclusive, but are for illustration only.) ALL EXPRESS AND IMPLIED WARRANTIES, INCLUDING THE WARRANTY OF MERCHANTABILITY, ARE LIMITED TO THE PERIOD OF THE LIMITED WARRANTY.

Some states do not allow the exclusion or limitation of incidental or consequential damages, or limitations on how long an implied warranty lasts, so the exclusions may not apply to you.

This warranty gives you specific legal rights and you may also have other rights which vary from state to state. If a problem with this product develops during or after the warranty period, you may contact your dealer or Servicenter. If the problem is not handled to your satisfaction, then write to the warrantor's Consumer Affairs Department at the addresses listed for the warrantor.

PARTS AND SERVICE WHICH ARE NOT COVERED BY THIS LIMITED WARRANTY ARE YOUR RESPONSIBILITY.

Customer Services Directory (For USA Only)

For Product Information, Operating Assistance, Literature Request, Dealer Locations, and all Customer Service inquiries please contact: 1-800-272-7033, Monday-Friday 8:30am-8pm EST.

Web Site: <http://www.panasonic.com/consumersupport>
You can purchase parts, accessories or locate your nearest servicer by visiting our Web Site.

Accessory Purchases

Purchase Parts, Accessories and Instruction Books online for all Panasonic Products by visiting our Web Site at:

<http://www.pasc.panasonic.com>

or, send your request by E-mail to:
npcparts@us.panasonic.com

You may also contact us directly at:
1-800-332-5368 (Phone) 1-800-237-9080 (Fax Only)
(Monday - Friday 9 am to 9 pm, EST.)
Panasonic Services Company 20421 84th Avenue South, Kent, WA 98032
(We Accept Visa, MasterCard, Discover Card, American Express, and Personal Checks)

Product Repairs

Centralized Factory Servicer

MAIL TO : Panasonic Services Company
410B Airport Road
Elgin, IL 60123-9333
Attention: Digital Camera Repair

Please carefully pack and ship, prepaid and insured, to the Elgin Centralized Factory Servicer.
Customer's in Puerto Rico, please ship or carry in to location below ("Service in Puerto Rico").

Service in Puerto Rico

Panasonic Puerto Rico, Inc.:
Ave. 65 de Infantería, Km. 9.5, San Gabriel Industrial Park,
Carolina, Puerto Rico 00985
Phone (787) 750-4300 Fax (787) 768-2910

As of May 2006

Index

A	
AC Adaptor	18, 19, 98, 100
Adjusting the flash output	61
AF Assist Lamp	82
AF Frame	85
AFC	35
AF-LED	86
AFS	32, 54
AF+MF	86
AF/AE Lock	63
AF/AE Lock Hold	86
Aperture-Priority AE	36
Aspect Ratio	79
Auto Bracket	66, 83
Auto Focus	32
Auto Review	28
Auto White Balance	69
B	
Beep	29
Body Cap	16
Bounce Flash	62
Built-in Flash	58
Bulb	39
Burst Mode	64
Burst Rate	83
C	
Calendar Playback	49
Card Access Indication	22
Center Weighted	72
Charging	18, 19
Clock Set	26, 28
Color Space	86, 99
Color Temperature Setting	70
Compensating the Exposure	40
Condensation	5
Continuous AF	35
Custom Set	85
Custom Set Memory	85, 87
D	
Date Printing	93, 102, 103
Delete	45
Depth of field	57
Digital Zoom	81
Diopter adjustment	31
DIREC. EX. COMP.	85

Display Set	87
DPOF Print	92
Dust Reduction Function	25

E

Exposure	35, 63
Extended Optical Zoom	80
External Flash	105
Eye cap	25
Eyepiece Cap	25
EZ	79, 80

F

Favorites	90
File number	29, 99
Film Mode	76
Fine	78
Finely Adjusting the White Balance	70
Flash	58, 105
Flash Synchro	83
Flash sync. speed	60
Focus	34, 42, 63
Focus distance indicator	42, 55
Focus distance reference line	42
Focus priority	86
Folder composition	99
Folder number	29, 99
Formatting	97
FUNC.1 Set	73, 85
FUNC.2 Set	73, 85

G

Guide line	51
------------------	----

H

High angle mode	53
Highlight Display	29
Histogram	52
Hot shoe	105

I

ISO sensitivity	71
-----------------------	----

J

Jitter	35
--------------	----

L

Language Setting	30
Layout	102
LCD Auto	85

Others

LCD monitor	14
Lens	16
Lens Cap	17
Lens Hood	23
Lens rear cap	16
Live View	50
LONG SHUTTER NR	87

M

MANUAL	89
Manual exposure	38
Manual Exposure Assistance	39
Manual Focus	42
Mass Storage	29
MC protector	106
Metering Mode	72
MF	42
MF Assist	28, 55
Mirror Up	87
Monitor	28
Multi Playback	48
Multiple	72

N

ND Filter	106
No release without lens	87
NO.RESET	29
NTSC	30, 104
Number of prints	92, 93, 102
Number of recordable pictures	19, 120

O

Optical Image Stabilizer	17, 82
--------------------------------	--------

P

PAL	30
Paper Size	102
PC	98
PictBridge	100
Picture Size	78, 120
Pixel Refresh	87
PL filter	106
Playback Pictures on TV	104
Playback Zoom	47
Power Save	28
Program AE	32
Program shift	33
Protect	94

Q

Quality	78
---------------	----

R

RAW file simultaneously	79
Remote Shutter	107
RESET	29
Resize	94
Rotate	91
Rotate Display	91

S

Screen Display	13
Self Timer	67, 81
Setup Menu	27
Shutter-priority AE	36
Slide Show	89
Spot	72
Standard	78
Strap	24
Super Fine	78

T

Trimming	95
Turning the Camera ON	25
TV aspect	30

U

USB connection cable	98, 100, 101
USB Mode	29, 98, 101

V

Video output	30, 104
Viewfinder	13, 31

W

White Set	70
World Time	28, 108

Z

Zoom	47, 80, 81
------------	------------

Spanish Quick Use Guide/Guía rápida en español

- Cárquela antes del uso.
- Compruebe que la cámara esté apagada.
- Cierre el flash.

■ Preparaciones

1 Conecte el cable CA.

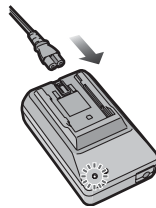

- Cuando el cable de CC está conectado a un adaptador de CA la batería no puede ser cargada.

2 Inserte hasta que dispare la batería enteramente cargada.

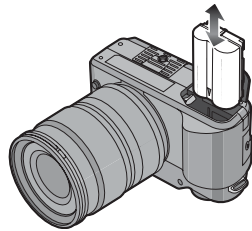

- Ponga atención en la dirección indicada por la marca [▼] en la batería cuando la va a insertar.

- #### 3
- 1 Cierre la tapa de la batería.
 - 2 Desplace la palanca de desenganche en la dirección de la flecha (lado CLOSE) y, luego, ciérrela firmemente.

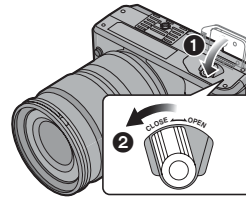

4 Desplace la tapa de la tarjeta para abrirla.

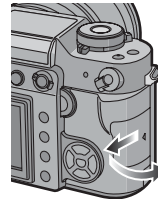

5 Inserte la tarjeta hasta que tope y se bloquee.

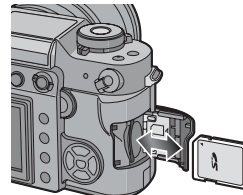

- Controle la dirección de la tarjeta.
- La tarjeta podría dañarse si no está introducida completamente.
- No toque el terminal de conexión por el lado trasero de la tarjeta.

- 6 ❶ Cierre la tapa de la tarjeta.
❷ Desplace la tapa de la tarjeta hasta el fin, luego ciérrela firmemente.

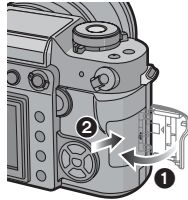

■ Grabación

- Quite la tapa del objetivo.
- Encienda la cámara.
- Ajuste la palanca del modo de disparo a [□].

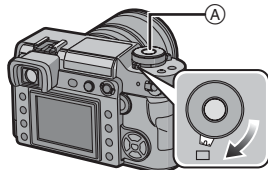

A: Botón del obturador

- 1 Ajuste la palanca del modo del enfoque a [AFS].

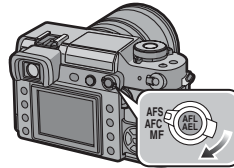

- AFS es la abreviación de “Auto Focus Single”. El enfoque se fija cuando pulsa a mitad el botón del obturador.

- 2 Gire el disco de la velocidad de obturación hacia [A].

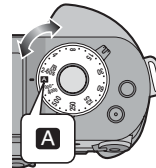

- 3 Gire el anillo de apertura hacia [A], mientras pulsa el botón de dicho anillo [B].

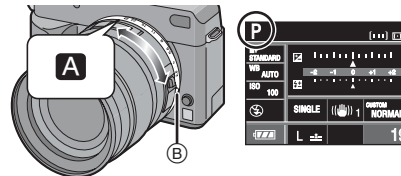

- El modo pasa al de la AE programada [P].

4 Dirija el encuadre AF C hacia el punto que quiere enfocar, luego pulse a mitad el botón del obturador.

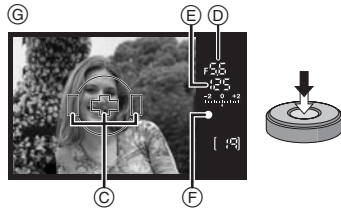

- Ⓒ: Visualización del visor
- Puede comprobar el valor de la abertura D y la velocidad de obturación visualizados E .
 - Una vez que el sujeto esté enfocado, la cámara emite un bip y se enciende la indicación del enfoque F .

5 Pulse a tope el botón del obturador para tomar la imagen.

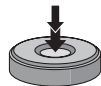

■ Reproducción

1 Pulse [▶] .



2 Pulse ◀/▶ para seleccionar la imagen.



- ◀: Reproducir la imagen anterior
- ▶: Reproducir la imagen siguiente
- La primera imagen grabada aparecerá tras la última grabada.

■ Borrado

1 Seleccione la imagen con ◀/▶ .



- ◀: Reproducir la imagen anterior
- ▶: Reproducir la imagen siguiente

2 Pulse [⏏] .

3 Pulse ▲ para seleccionar [YES] luego pulse [MENU/SET] .



- Mientras está borrando la imagen, [⏏] aparece en la pantalla.

**Panasonic Consumer Electronics Company,
Division of Panasonic Corporation of North America**

One Panasonic Way, Secaucus, NJ 07094

Panasonic Puerto Rico, Inc.

Ave. 65 de Infantería, Km. 9.5, San Gabriel Industrial Park, Carolina, Puerto Rico 00985

Panasonic Canada Inc.

5770 Ambler Drive, Mississauga, Ontario, L4W 2T3

© 2006 Matsushita Electric Industrial Co., Ltd.



VQT0W82

F0706Sy0 (2100 A)

